

**ALUMINCO**<sup>®</sup>  
ALUMINIUM BUILDING SYSTEMS

# DOOR PANELS





## Περιεχόμενα Index

Προφίλ εταιρείας Company profile	2-3
Ευρετήριο σχεδίων Design index	4-7
<b>P100 Series</b>	8-25
<b>Inox Series</b>	26-49
<b>E2000 Series</b>	50-105
<b>P6000 Series</b>	106-123
Ταμπλαδάκια Special size panels	124
<b>FP20</b> Aluplast / PVC	125
Χειρολαβές Handles	126-127
<b>Security door lock</b>	128-129
<b>HDS ULTRA PLUS</b>	130

## Στη κορυφή της βιομηχανίας αλουμινίου, προσφέροντας καινοτόμες λύσεις αρχιτεκτονικών συστημάτων αλουμινίου

Η ALUMINCO A.E. ξεκίνησε το 1982 πρωτοπόρος με όραμα και ισχυρή επιχειρηματική κουλτούρα. Από την πρώτη κιόλας ημέρα δραστηριοποίησης της, έθεσε ως σκοπό της, την καινοτομία και πρωτοπορία στον τομέα της συνεχούς έρευνας, ανάπτυξης και παραγωγής προϊόντων αλουμινίου, που ανταποκρίνονται ποιοτικά, αισθητικά και λειτουργικά στις απαιτητικές και ταχύτατα εξελισσόμενες αγορές.

Σήμερα, αξιοποιώντας πάνω από τρεις δεκαετίες εμπειρίας και με συνεχείς καινοτομίες και επενδύσεις σε εξοπλισμό υποδομής και προσωπικό, έχει μετεξελιχθεί σε μια ολοκληρωμένη, κάθετη βιομηχανία αλουμινίου.

Η ALUMINCO είναι πιστοποιημένη με ISO 9001 και ISO 14001, QUALICOAT SEASIDE CLASS, ενώ όλες οι σειρές προϊόντων μας είναι πιστοποιημένες από Διεθνή Ιδρύματα για τα εξαιρετικά χαρακτηριστικά και τις επιδόσεις τους.

Ο σταθερά πρωταγωνιστικός ρόλος της ALUMINCO στην ελληνική αγορά και η συνεχής ανάπτυξη σε αγορές του εξωτερικού ανέδειξαν σταδιακά την εταιρεία ανάμεσα στις ηγετικές ελληνικές βιομηχανίες αλουμινίου και στις πλέον σεβαστές και αναγνωρίσιμες παγκοσμίως.

Στα Οινόφυτα Βοιωτίας, σε ιδιόκτητη γη 60.000 τ.μ., βρίσκονται οι κεντρικές εγκαταστάσεις ALUMINCO, οι οποίες περιλαμβάνουν Διοικητικές Υπηρεσίες, Μονάδες Παραγωγής και Logistics.

### **Παγκόσμια παρουσία, διεθνής εμπειρία**

Το δίκτυο διανομής της ALUMINCO εξυπηρετεί τις πιο σημαντικές αγορές της Ευρώπης, της Αφρικής, της Ασίας και της Αμερικής, διανέμοντας προϊόντα αλουμινίου σε περισσότερες από 60 χώρες παγκοσμίως.



## Aluminco is among the top suppliers of innovative architectural aluminium systems

ALUMINCO S.A. was established in 1982, to meet the increasing demand for innovative products and bring life to the aluminium systems. Its vision was to become a premium, worldwide Aluminium supplier of systems that meet evolution.

After three decades of experience and dedication to a continuous production upgrade capacity and human resources, the company has become a leading provider in the aluminium industry.

Targeting the international community of architects, designers, engineers, construction perfectionists and fabricators, ALUMINCO offers a complete range of architectural aluminium solutions that are innovative, energy efficient and sustainable, embodying top quality, high functionality and contemporary design standards. ALUMINCO is an ISO 9001 and ISO 14001 certified company, QUALICOAT SEASIDE CLASS accredited, while all our product lines are certified by International Institutions for their outstanding characteristics and performances.

Aluminco's headquarters include the production facilities, the logistics department and the administration offices and are located in privately owned premises of 60.000 sq. m. in the Industrial Zone of Inofyta Viotias.

### **International presence and recognition**

ALUMINCO's network covers a significant number of European countries as well as Africa, Middle East, Australia and the U.S.A, and stretches its boundaries in more than 60 countries worldwide.





# ΚΑΤΑΛΟΓΟΣ ΠΕΡΙΕΧΟΜΕΝΩΝ ΜΕ ΔΙΑΣΤΑΣΕΙΣ ΣΧΕΔΙΩΝ

P100 Series

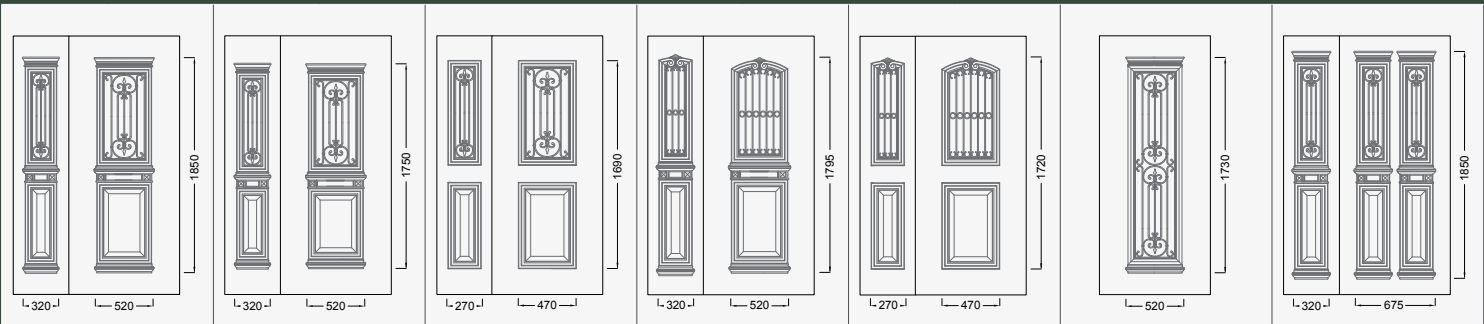

**P105-P100** Pg.12-13    **P105K-P100K** Pg.27    **P106-P101** Pg.10-11    **P115-P110** Pg.16-17    **P116-P111** Pg.16    **P124** Pg.13    **P105-P130** Pg.14

i300 Series

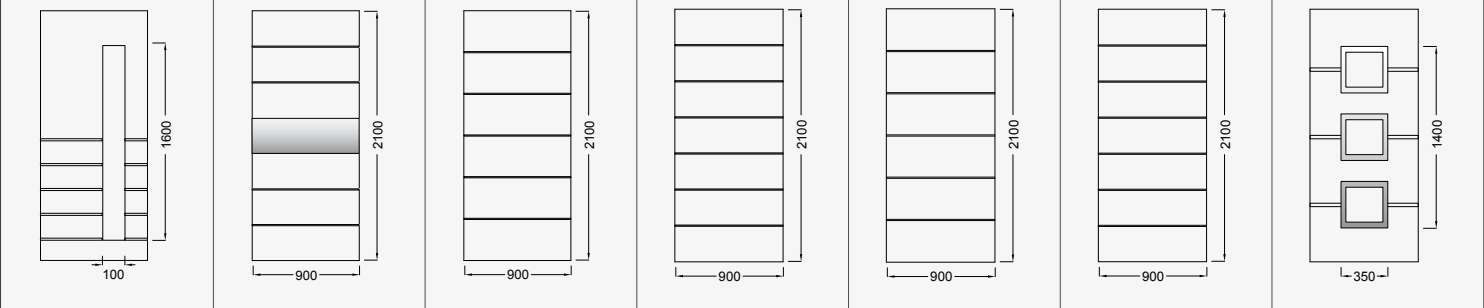

**i221** Pg. 30    **i224** Pg. 33    **i225** Pg. 29    **i226** Pg. 28    **i235** Pg. 32    **i236** Pg. 32    **i240** Pg. 32

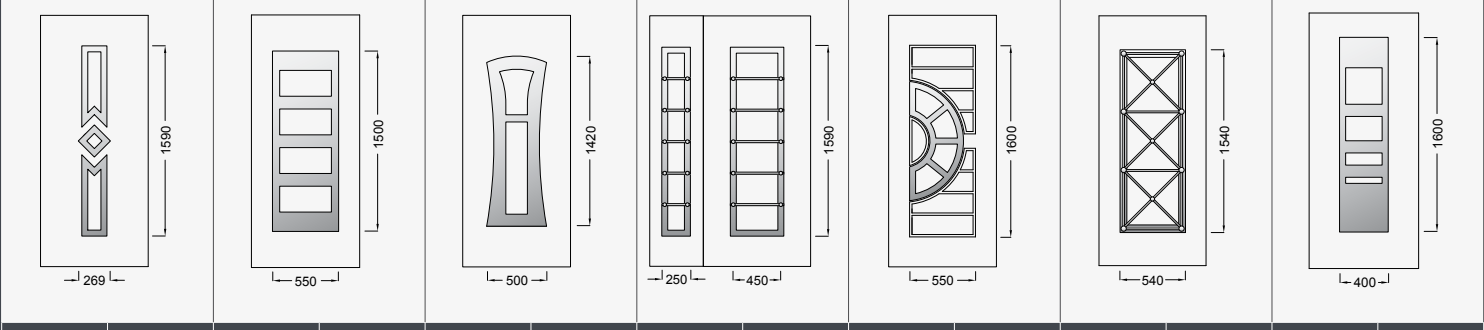

**i320** Pg. 36    **i325** Pg. 38    **i335** Pg. 41    **i383-i343** Pg. 34    **i345** Pg. 38-39    **i347** Pg. 34    **i350** Pg. 41

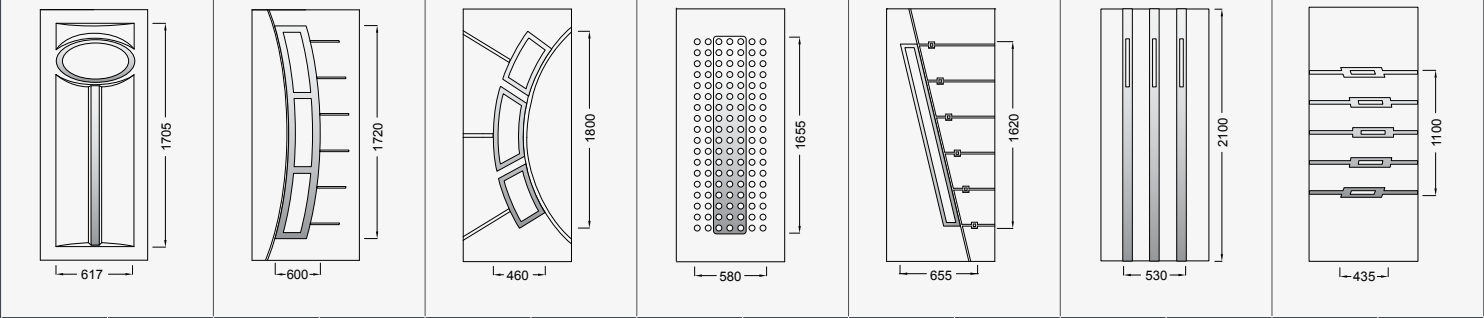

**i405** Pg. 45    **i420** Pg. 49    **i425** Pg. 49    **i429** Pg. 46    **i450** Pg. 46    **i455** Pg. 47    **i460** Pg. 45

E2000 Series

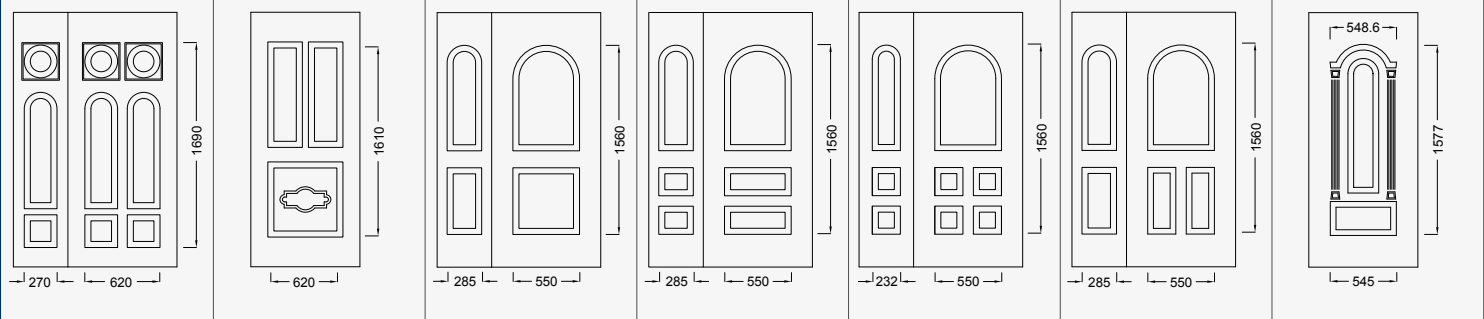

**E210-E200** Pg. 104    **E507** Pg. 52    **E903-E510** Pg. 60-61    **E504-E512** Pg. 60-61    **E588-E513** Pg. 60, 62    **E903-E517** Pg. 60, 63    **E528** Pg. 54



# CATALOGUE INDEX WITH DESIGN DIMENSIONS

<b>P106-P131</b> Pg.21	<b>P105-P136</b> Pg.15	<b>P115-P140</b> Pg.16	<b>P164</b> Pg.19	<b>P138-P168</b> Pg.24	<b>P177-P176</b> Pg.18, 20	<b>P129-P189</b> Pg.23-24
<b>I245</b> Pg. 28	<b>I253</b> Pg. 31	<b>I260</b> Pg. 30	<b>I270</b> Pg. 31	<b>i313-i300</b> Pg. 37	<b>i310</b> Pg. 36	<b>P190</b> Pg.22
<b>i357</b> Pg. 44	<b>i362</b> Pg. 42	<b>i375</b> Pg. 42	<b>i388-i378</b> Pg. 35	<b>i380</b> Pg. 40	<b>i385</b> Pg. 40	<b>i392</b> Pg. 43
<b>i465</b> Pg. 47	<b>i480</b> Pg. 48	<b>i490</b> Pg. 48	<b>i495</b> Pg. 44			
<b>E810-E530</b> Pg. 58	<b>E532</b> Pg. 55	<b>E534</b> Pg. 57	<b>E536</b> Pg. 56	<b>E554-E540</b> Pg. 60, 62	<b>E545</b> Pg. 59	

# ΚΑΤΑΛΟΓΟΣ ΠΕΡΙΕΧΟΜΕΝΩΝ ΜΕ ΔΙΑΣΤΑΣΕΙΣ ΣΧΕΔΙΩΝ

E2000 Series

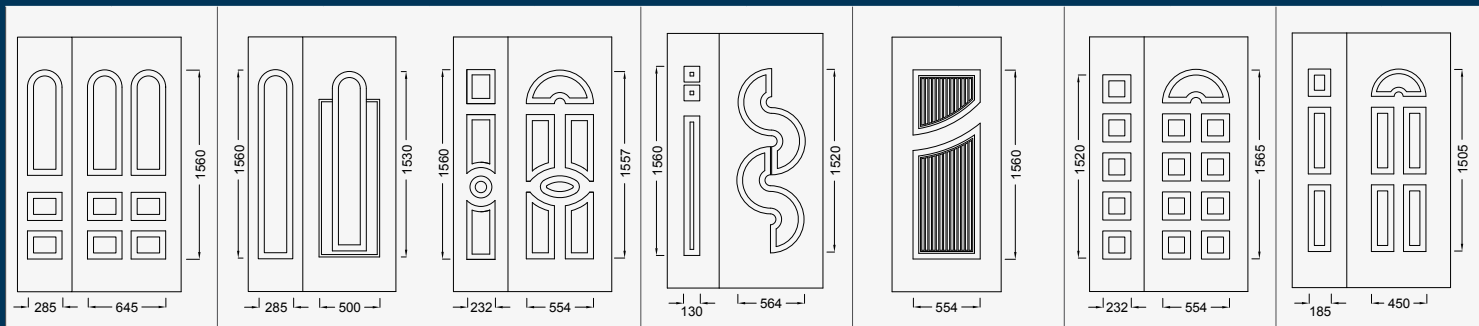

**E504-E550** Pg. 64    **E907-E552** Pg. 70    **E856-E556** Pg. 65    **E562-E560** Pg. 68    **E564** Pg. 66    **E572-E566** Pg. 67    **E590-E580** Pg. 69

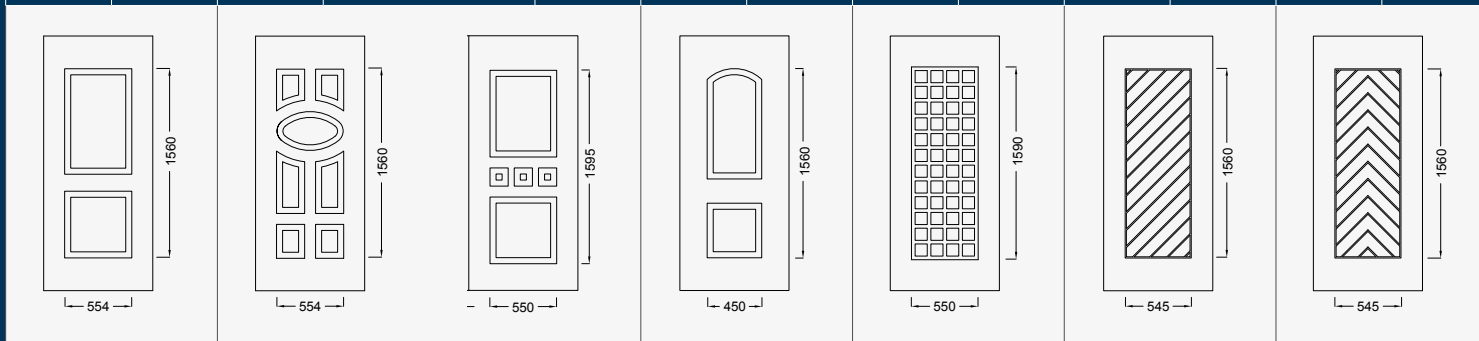

**E740** Pg. 77    **E750** Pg. 81    **E760** Pg. 76    **E770** Pg. 82    **E780** Pg. 78    **E781** Pg. 79    **E782** Pg. 79

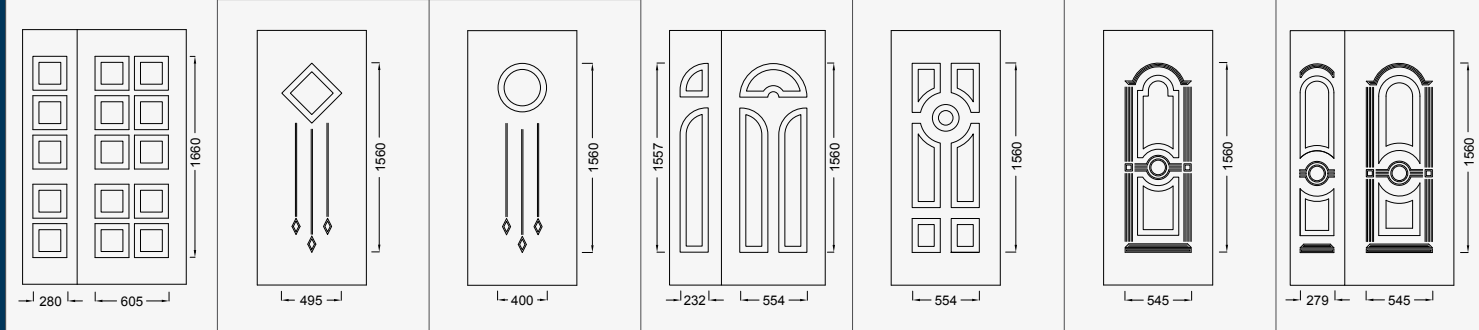

**E520-E820** Pg. 85    **E845** Pg. 87    **E847** Pg. 86    **E854-E850** Pg. 88    **E860** Pg. 75    **E870** Pg. 89    **E865-E873** Pg. 90

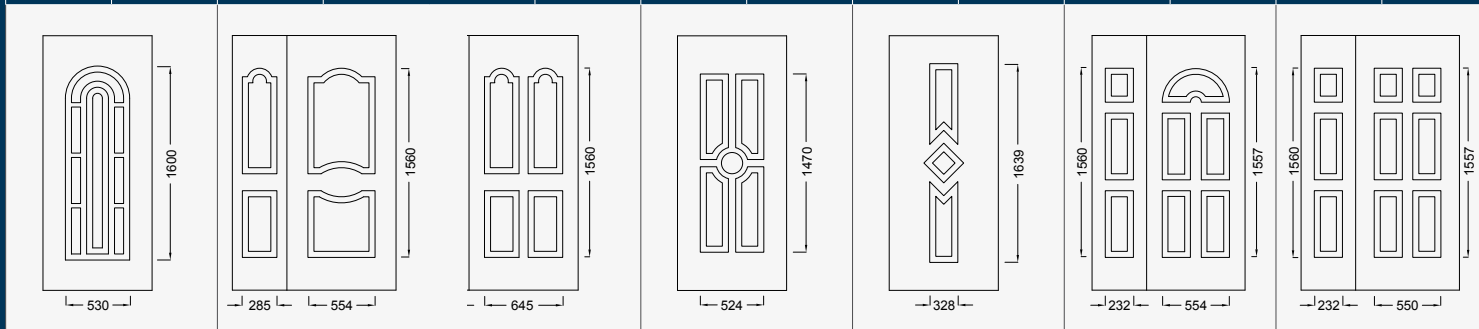

**E922** Pg. 99    **E933-E926** Pg. 97    **E941** Pg. 98    **E951** Pg. 101    **E957** Pg. 100    **E986-E982** Pg. 102-103    **E986-E990** Pg. 105

P6000 Series

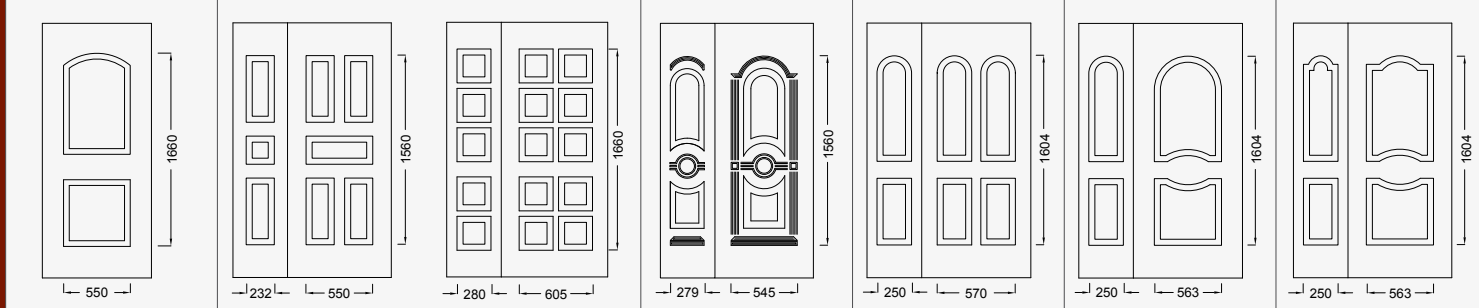

**P6170** Pg. 118    **P6680-P6180** Pg. 123    **P6690-6190** Pg. 111    **P6700-P6200** Pg. 115    **P6710-P6210** Pg. 120    **P6710-P6220** Pg. 119    **P6740-P6230** Pg. 116, 123

# CATALOGUE INDEX WITH DESIGN DIMENSIONS

<b>E586</b> Pg. 53	<b>E986-E700</b> Pg. 71	<b>E710</b> Pg. 72	<b>E714</b> Pg. 79	<b>E720</b> Pg. 74	<b>E986-E725</b> Pg. 73	<b>E728</b> Pg. 74
<b>E783</b> Pg. 78	<b>E784</b> Pg. 79	<b>E785</b> Pg. 78	<b>E789</b> Pg. 79	<b>E790</b> Pg. 80	<b>E800-E803</b> Pg. 83	<b>E810-E812</b> Pg. 84
<b>E562-E875</b> Pg. 68	<b>E880</b> Pg. 91	<b>E562-E884</b> Pg. 68	<b>E892-E895</b> Pg. 92	<b>E897</b> Pg. 93	<b>E903-E902</b> Pg. 94-95	<b>E903-E910</b> Pg. 96
<b>P6600-P6100</b> Pg. 108	<b>P6110</b> Pg. 109	<b>P6120</b> Pg. 110	<b>P6630-P6130</b> Pg. 112	<b>P6750-P6140</b> Pg. 113	<b>P6150</b> Pg. 114	<b>P6160</b> Pg. 117
<b>P6740-P6240</b> Pg. 121	<b>P6750-P6250</b> Pg. 122					



# P100 Series



P102



P102K



P103



P112



P113



P152



# Παραδοσιακό | Traditional

- Νεοκλασικός χαρακτήρας
  - Φύλλο αλουμινίου 1.2 mm
  - Τζάμια με ασφάλειες αλουμινίου
  - Επιλογή ανοιγόμενου παραθύρου
  - Εύκολη και άμεση αντικατάσταση τζαμιών με βίδες
  - Μεγάλη γκάμα σχεδίων και κατασκευών
  - Αναλλοίωτες και πιστοποιημένες βαφές και αποχρώσεις ξύλου
  - Δεν χρειάζεται συντήρηση
- Traditional and classic design
  - 1.2 mm Aluminium sheet
  - Window with aluminium decorative safety
  - Opening window option
  - Quick and easy glass replacement with screws
  - Multiple design option
  - Certified powder coatings and wood imitation shades
  - Maintenance free

ΠΑΧΟΣ ΦΥΛΛΟΥ ΑΛΟΥΜΙΝΙΟΥ  
ALUMINIUM SHEET THICKNESS

1.2 mm

ΠΑΧΟΣ ΔΙΑΚΟΣΜΗΤΙΚΟΥ ΧΥΤΟΥ  
DECORATIVE CAST THICKNESS

4 mm

ΣΥΝΟΛΙΚΟ ΠΑΧΟΣ ΠΑΝΕΛ  
TOTAL PANEL THICKNESS

23-25 mm

ΑΠΟΚΟΛΛΗΣΗ ΚΟΡΝΙΖΑΣ ΑΠΟ  
ΕΠΙΦΑΝΕΙΑ ΤΟΥ ΠΑΝΕΛ  
FRAME DETACHMENT FROM  
PANEL SURFACE

50.02 Pa/mm<sup>2</sup>

ΑΠΟΚΟΛΛΗΣΗ ΦΥΛΛΟΥ  
ΑΛΟΥΜΙΝΙΟΥ ΑΠΟ ΜΟΝΩΤΙΚΟ  
SHEET DETACHMENT FROM  
INSULATION MATERIAL

0.488 N/mm<sup>2</sup>

ΘΕΡΜΟΠΕΡΑΤΟΤΗΤΑ ΠΑΝΕΛ  
PANEL THERMAL CONDUCTIVITY

U<sub>p</sub>=1.08 W/m<sup>2</sup>K (max)

ΣΥΝΤΕΛΕΣΤΗΣ ΘΕΡΜΙΚΗΣ  
ΑΝΤΙΣΤΑΣΗΣ ΠΑΝΕΛ  
PANEL THERMAL RESISTANCE  
COEFFICIENT

R<sub>p</sub>=0.93 m<sup>2</sup>K/W (max)

ΣΥΝΤΕΛΕΣΤΗΣ ΘΕΡΜΙΚΗΣ ΑΓΩΓΙΜΟΤΗΤΑΣ EPS  
EPS THERMAL CONDUCTIVITY COEFFICIENT

λ=0.033 W/mK



P142



P143



P162



P132



P133



P190

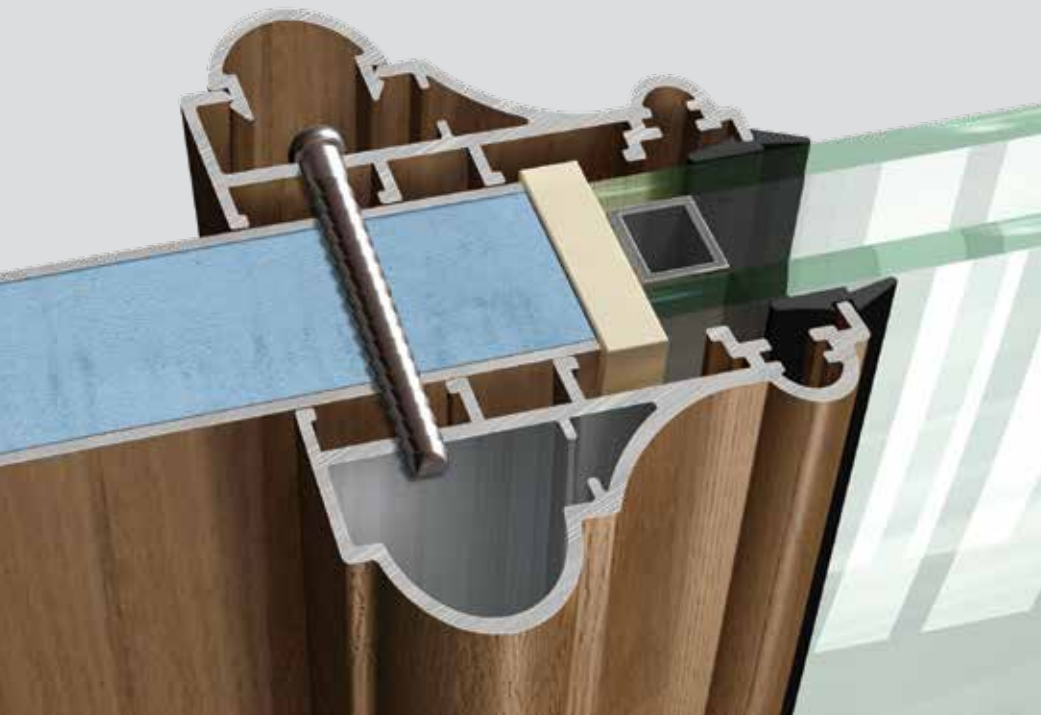

# P100 Series

Classic



P106

P101

Επιλογή διακοσμητικής ασφάλειας  
εσωτερικά του κρυστάλλου.  
Decorative safety option



P121



P181

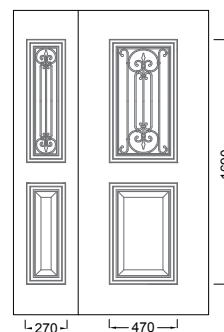





P158 Vitro-B K (Brown)

Επιλογή Vitro  
Vitro option



Vitro-A Π (Green)

# P100 Series

Classic



P105

P100

Επιλογή διακοσμητικής ασφάλειας  
εσωτερικά του κρυστάλλου.  
Decorative safety option



P125



P120



P175



P170



P183



P158 Vitro-A K (Green)



P124

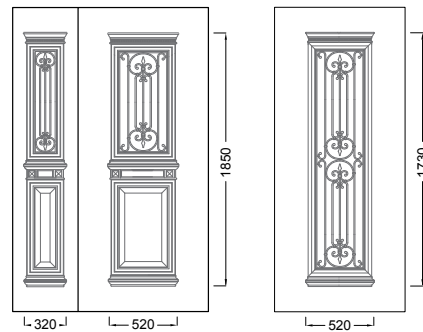



# P100 Series

Classic



P175

P171

Επιλογή διακοσμητικής ασφάλειας  
εσωτερικά του κρυστάλλου.  
Decorative safety option



P130



P150

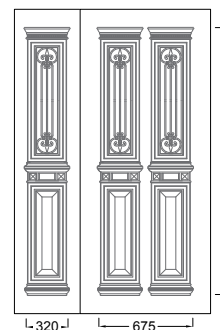



P105

P136

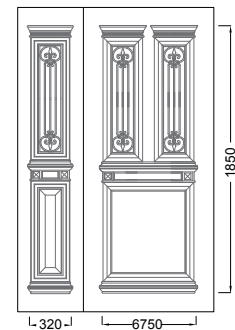

# P100 Series

Classic



P140



P116

P111



P115

P110

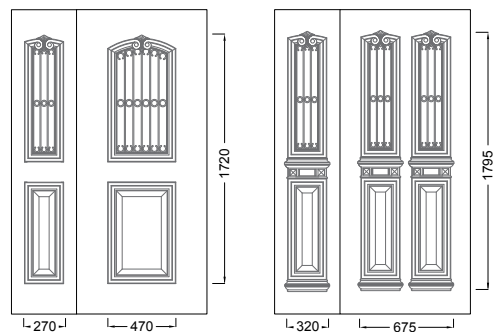



P110 Vitro-B M (Blue)

Επιλογή Vitro  
Vitro option



Vitro-B Λ (White)

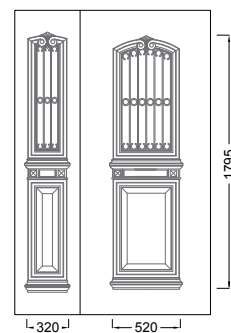



# P100 Series

Classic



P185

P180

Επιλογή διακοσμητικής ασφάλειας  
εσωτερικά του κρυστάλλου.  
Decorative safety option

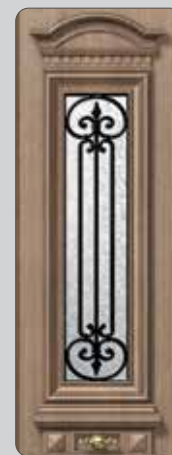

P177



P176



P179



P178



P182





P160



P162



P164



P163

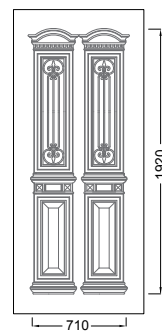
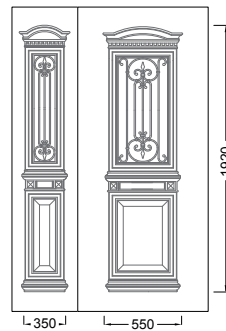

# P100 Series

Classic



P154 Vitro-A M (Green)



P152

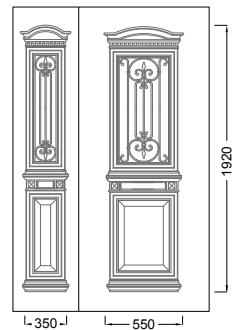



P151



P161



P131

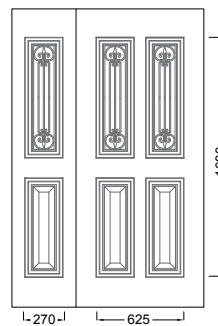

# P100 Series

Classic



P193



P191

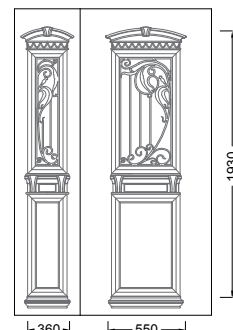
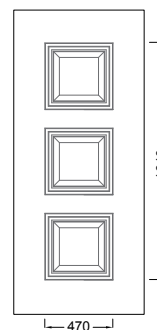





P129

P189

Επιλογή διακοσμητικής ασφάλειας  
εσωτερικά του κρυστάλλου.  
Decorative safety option



P109



P149



P128



P148

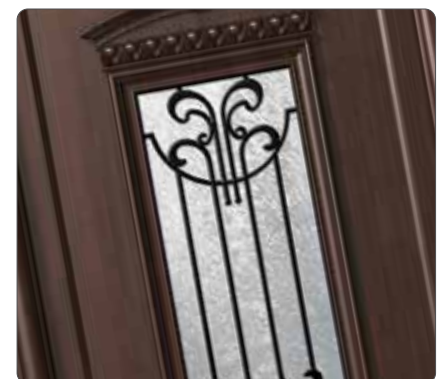

P198



# P100 Series

Classic



P138

P168

Επιλογή διακοσμητικής ασφάλειας  
εσωτερικά του κρυστάλλου.  
Decorative safety option



P194



P174



P114



P169

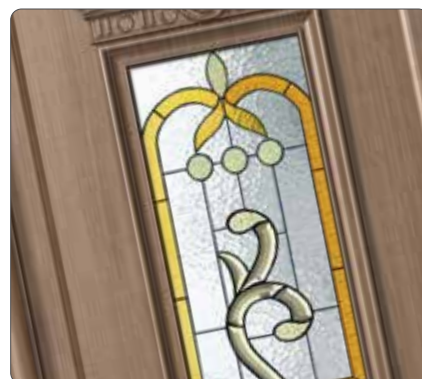
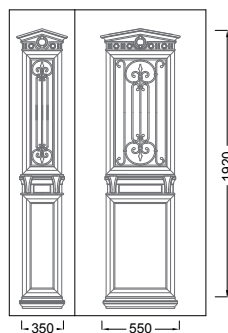

P168 Vitro-B K (Brown)



P199

## ΕΙΔΙΚΟ ΣΧΕΔΙΟ

Το ύψος των σχεδίων της σειράς P100 μπορεί να μειωθεί κατά 10 cm. Εξαιρούνται τα σχέδια P190, P191, P192, P193.

## SPECIAL DESIGN

The height of the P100 series can be reduced by 10 cm. Panel designs with code P190, P191, P192, P193 are excluded from this feature.



P107 K

P102 K



P175 K

P170 K



P105 K

P100 K

# i300 Series



i460



i455



i466



# Μοντέρνο | Modern

- Έντονα μοντέρνος χαρακτήρας
- Τζάμια διπλής υάλωσης
- Επιλογές ειδικά κατεργασμένων τζαμιών
- Fused υψηλής αισθητικής και αυξημένης αντοχής
- Αυξημένη θερμομόνωση & ηχομόνωση
- Αναλλοίωτες και πιστοποιημένες βαφές και αποχρώσεις ξύλου
  
- Innovative design
- Double glazing
- Fused glazing with Inox for extra resistance and high aesthetics
- Exceptional heat and sound insulation coefficient
- Certified powder coatings and wood imitation shades

ΠΑΧΟΣ ΦΥΛΛΟΥ ΑΛΟΥΜΙΝΙΟΥ ALUMINIUM SHEET THICKNESS	
1.2 mm	2 mm
ΣΥΝΟΛΙΚΟ ΠΑΧΟΣ ΠΑΝΕΛ TOTAL PANEL THICKNESS	
23-25 mm	24-26 mm
ΑΠΟΚΟΛΜΗΣΗ ΚΟΡΝΙΖΑΣ ΑΠΟ ΕΠΙΦΑΝΕΙΑ ΤΟΥ ΠΑΝΕΛ FRAME DETACHMENT FROM PANEL SURFACE	
50.02 Pa/mm <sup>2</sup>	
ΑΠΟΚΟΛΜΗΣΗ ΦΥΛΛΟΥ ΑΛΟΥΜΙΝΙΟΥ ΑΠΟ ΜΟΝΩΤΙΚΟ SHEET DETACHMENT FROM INSULATION MATERIAL	
0.488 N/mm <sup>2</sup>	
ΘΕΡΜΟΠΕΡΑΤΟΤΗΤΑ ΠΑΝΕΛ PANEL THERMAL CONDUCTIVITY	
U <sub>p</sub> =1.08 W/m <sup>2</sup> K (max)	
ΣΥΝΤΕΛΕΣΤΗΣ ΘΕΡΜΙΚΗΣ ΑΝΤΙΣΤΑΣΗΣ ΠΑΝΕΛ PANEL THERMAL RESISTANCE COEFFICIENT	
R <sub>p</sub> =0.93 m <sup>2</sup> K/W (max)	
ΣΥΝΤΕΛΕΣΤΗΣ ΘΕΡΜΙΚΗΣ ΑΓΩΓΙΜΟΤΗΤΑΣ EPS EPS THERMAL CONDUCTIVITY COEFFICIENT	
λ=0.035 W/mK	

GET THE  
TIP

## ΟΔΗΓΙΕΣ ΣΥΝΤΗΡΗΣΗΣ ΙΝΟΧ ΣΤΟΙΧΕΙΩΝ

Θα χρειαστείτε: 1 σφουγγαράκι τύπου "Scotch Brite" και Υγρό απορρυπαντικό πιάτων. Τρίψτε την επιφάνεια inox με το σφουγγαράκι έχοντας το ποτίσει με μικρή ποσότητα υγρού πιάτων. Εφαρμόστε την παραπάνω διαδικασία είτε προληπτικά σε σύντομα χρονικά διαστήματα είτε σε περίπτωση που δείτε σημάδια διάβρωσης.

## INOX MAINTANCE INSTRUCTIONS

You will be needed: 1 "Scotch Brite" type of sponge & a dish wash liquid. Scrub the inox surface with the sponge initially dipped with a small quantity of the wash detergent. Apply the same procedure in short time periods either for precautionary reasons or in case you notice signs of corrosion.



# i300 Series

Πάχος φύλλου αλουμινίου 2mm  
Aluminium sheet thickness 2mm



1226



1245

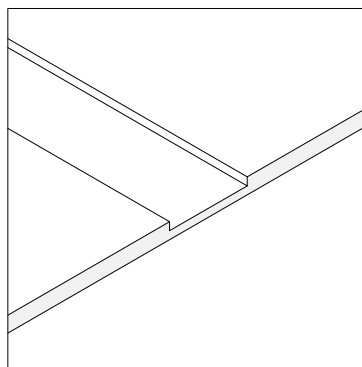
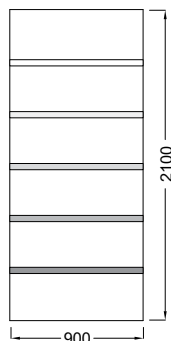
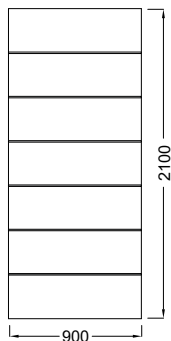

Δίνεται η δυνατότητα για 6 ή 7 ή 8 οριζόντιες χαράξεις  
Optional 6 or 7 or 8 horizontal engravings



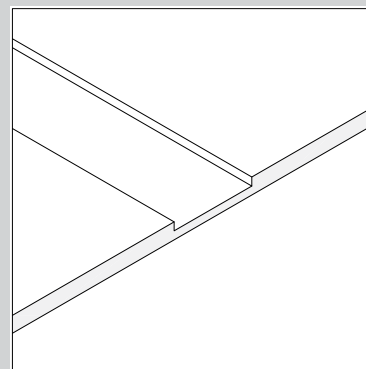

Δίνεται η δυνατότητα για 6 ή 7 ή 8 οριζόντιες χαραξίς  
Optional 6 or 7 or 8 horizontal engravings

- Πάχος φύλλου αλουμινίου 2mm
- Χάραξη πάνελ 1mm σε μορφή «Π»
- Λωρίδες Inox 10mm & 20mm
- Σχέδια πάνελ με 5 & 6 διακοσμητικές λωρίδες Inox
- Aluminium sheet thickness 2mm
- 1mm milling in «Π» shape
- 10mm & 20mm Inox lines
- Panel design with 5 & 6 Inox lines

# i300 Series

Πάχος φύλλου αλουμινίου 2mm  
Aluminium sheet thickness 2mm



I243 AMM



I263 Deco 3



I221 Super Silver

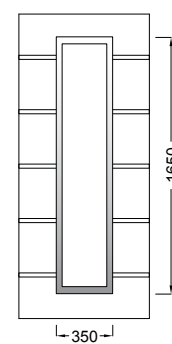
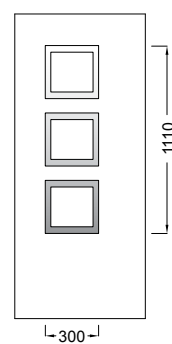
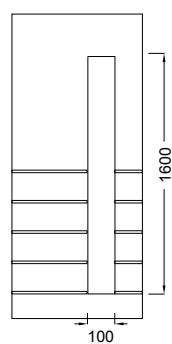
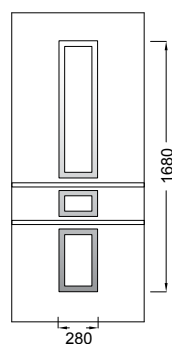
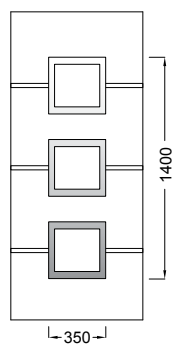



I253 Super Silver



I271 Super Silver

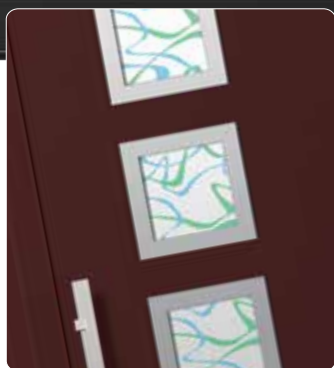

I253 Deco 3

- Διακοσμητικό καθρεπτίζον τζάμι Super Silver.
- Καθρέπτης εξωτερικά, φθοριωμένο τζάμι εσωτερικά.
- Decorative mirror glass Super Silver.
- Mirror effect outside
- Oxide glass inside.

# i300 Series

Πάχος φύλλου αλουμινίου 2mm  
Aluminium sheet thickness 2mm



I236 (6 Διακοσμητικές γραμμές / 6 Decorative lines)



I235 (5 Διακοσμητικές γραμμές / 5 Decorative lines)

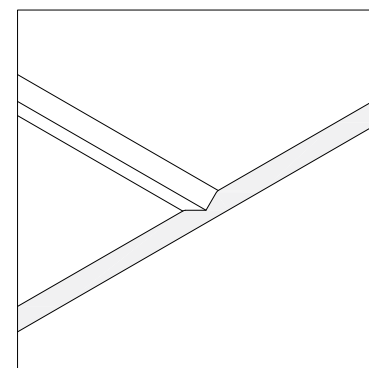
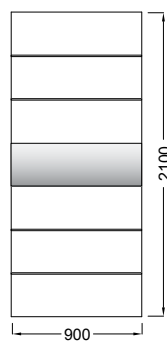
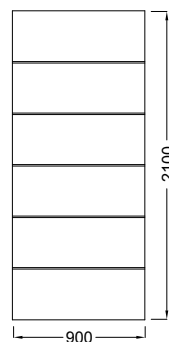
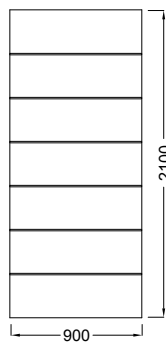

Δίνεται η δυνατότητα για 6 ή 7 ή 8 οριζόντιες χαράξεις  
Optional 6 or 7 or 8 horizontal engravings

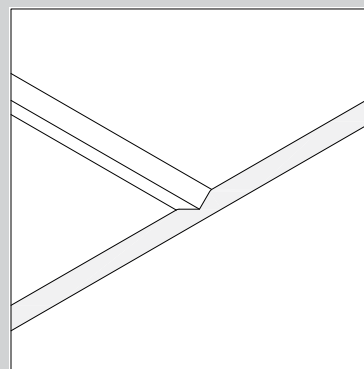

- Πάχος φύλλου αλουμινίου 2mm
- Χάραξη πάνελ 0.8mm σε μορφή «V»
- Σχέδια πάνελ με 5 & 6 διακοσμητικές γραμμές

- Aluminium sheet thickness 2mm
- 0.8mm milling in «V» shape
- Panel design with 5 & 6 milled lines



# i300 Series

Πάχος φύλλου αλουμινίου 2mm  
Aluminium sheet thickness 2mm



i348 Αμμοβολή/Sand Blasted Glass



i384 Super Silver

i344 Super Silver

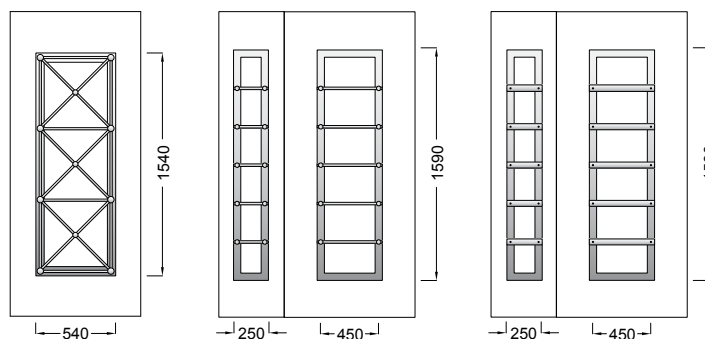



I389 Αμμοβολή/Sand Blasted Glass

I379 Αμμοβολή/Sand Blasted Glass



Κουρμπριστή ασφάλεια πάχους  
3mm & πλάτους 50mm.

Curved safety with 3mm  
thickness & 50mm width.

# i300 Series

Inox



i311M CA



i323 FU-1



i323 CA

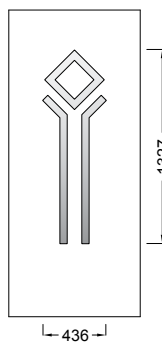

436

1327

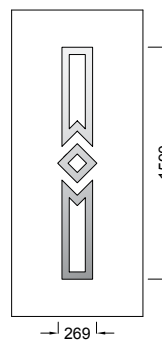

269

1590



i315 FU-1

i303 FU-1



i313

i307 CA



i313

i303 CA

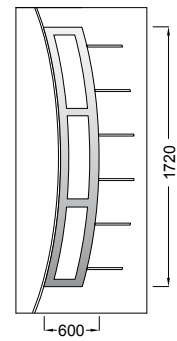
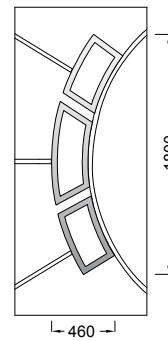
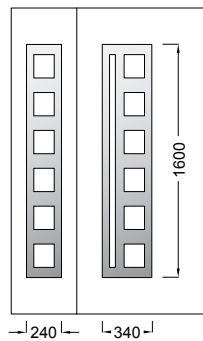

# i300 Series

Inox



i327 VI-1



i346 BR-2

Διακοσμητικά τζάμια & Vítro  
Decorative glass & Vítro



i327 CA

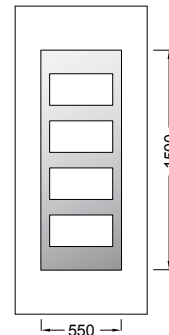
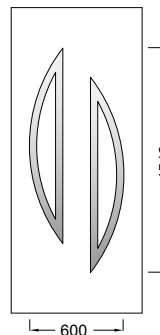



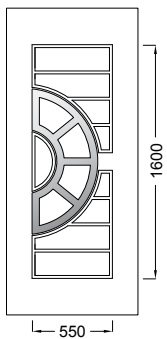

i346 FU-3

# i300 Series

Πάχος φύλλου αλουμινίου 1.2mm  
Aluminium sheet thickness 1.2mm



i382M FU-1



i387 Super Silver

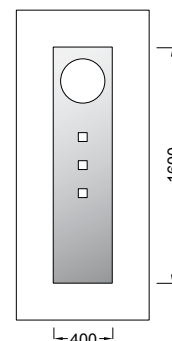
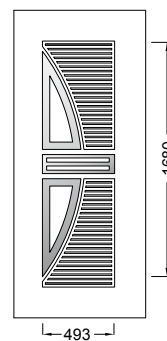



i354 Super Silver



i337M FU-1

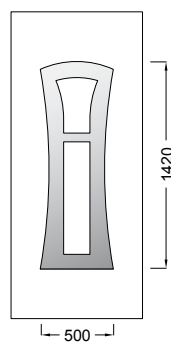
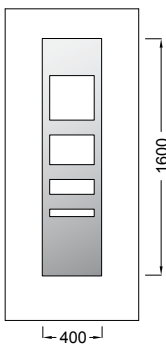

# i300 Series

Inox



i363 Super Silver



i376 CA

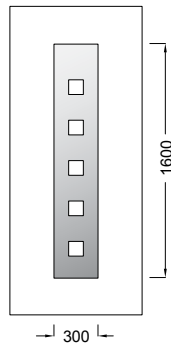
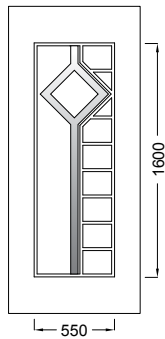

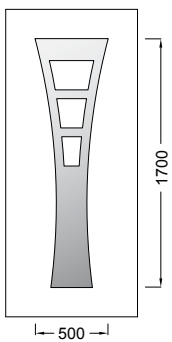

i395M FU-3



# i300 Series

Inox

1 mm

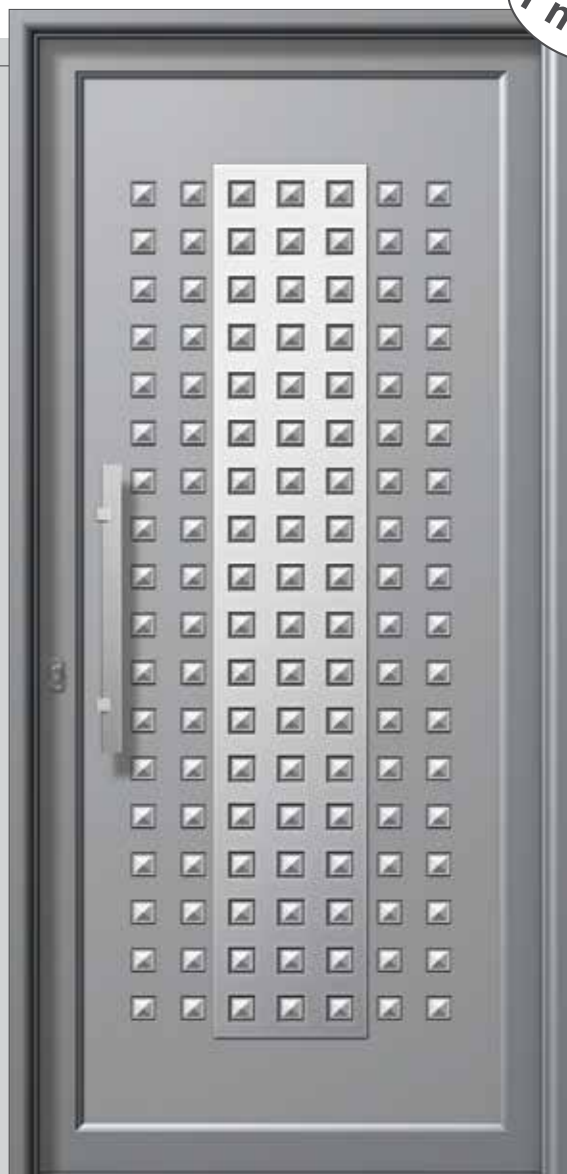

i357



i496 Αμμοβολή/Sand Blasted Glass

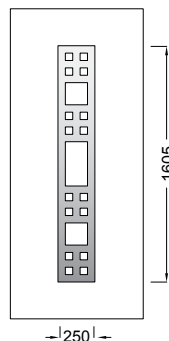
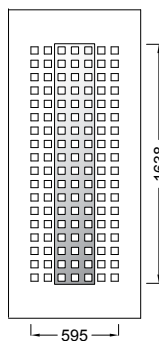



i406 Super Silver



i460

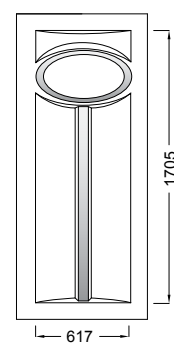
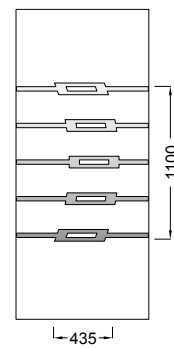

# i300 Series

Inox



i451 Super Silver



i429

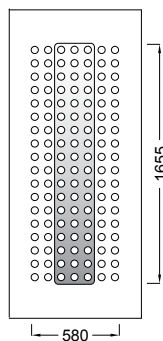
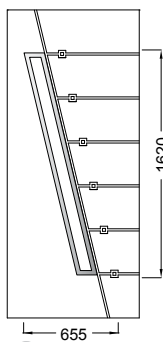



i455



i466 CA

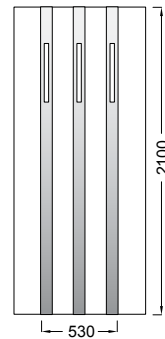
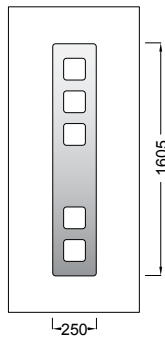

# i300 Series

Πάχος φύλλου αλουμινίου 1.2mm  
Aluminium sheet thickness 1.2mm



i491 BR-2



i481 CA

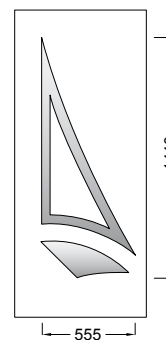
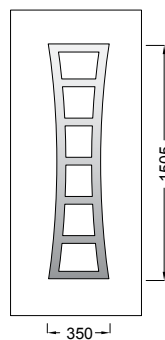





i428 Αμμοβολή/Sand Blasted Glass



i423 Super Silver

# E2000 Series



E532



E982



# Ευέλικτο | Flexible

- Μοντέρνος χαρακτήρας
  - Ευέλικτο design
  - Μεγάλη γκάμα κρυστάλλων
  - Τζάμια διπλής υάλωσης
  - Επιλογές ειδικά καταργασμένων τζαμιών
  - Fused υψηλής αισθητικής και αυξημένης αντοχής
  - Επιλογές ενσωματωμένων ασφαλειών για αντικλεπτική προστασία
  - Τεράστια ποικιλία σχεδίων και κατασκευών
  - Αναλλοίωτες και πιστοποιημένες βαφές και αποχρώσεις ξύλου
  - Δεν χρειάζεται συντήρηση
- 
- Modern design
  - Wide selection of glasses
  - Double glazing
  - Fused glazing with Inox for extra resistance and high aesthetics
  - Cast aluminium security for extra protection
  - Multiple design option
  - Certified powder coatings and wood imitation shades
  - Maintenance free

ΠΑΧΟΣ ΦΥΛΛΟΥ ΑΛΟΥΜΙΝΙΟΥ ALUMINIUM SHEET THICKNESS
1 mm
ΣΥΝΟΛΙΚΟ ΠΑΧΟΣ ΠΑΝΕΛ TOTAL PANEL THICKNESS
23-24 mm
ΑΠΟΚΟΛΛΗΣΗ ΚΟΡΝΙΖΑΣ ΑΠΟ ΕΠΙΦΑΝΕΙΑ ΤΟΥ ΠΑΝΕΛ FRAME DETACHMENT FROM PANEL SURFACE
50.02 Pa/mm <sup>2</sup>
ΑΠΟΚΟΛΛΗΣΗ ΦΥΛΛΟΥ ΑΛΟΥΜΙΝΙΟΥ ΑΠΟ ΜΟΝΩΤΙΚΟ SHEET DETACHMENT FROM INSULATION MATERIAL
0.488 N/mm <sup>2</sup>
ΘΕΡΜΟΠΕΡΑΤΟΤΗΤΑ ΠΑΝΕΛ PANEL THERMAL CONDUCTIVITY
U <sub>p</sub> =1.11 W/m <sup>2</sup> K (max)
ΣΥΝΤΕΛΕΣΤΗΣ ΘΕΡΜΙΚΗΣ ΑΝΤΙΣΤΑΣΗΣ ΠΑΝΕΛ PANEL THERMAL RESISTANCE COEFFICIENT
R <sub>p</sub> =0.90 m <sup>2</sup> K/W (max)
ΣΥΝΤΕΛΕΣΤΗΣ ΘΕΡΜΙΚΗΣ ΑΓΩΓΙΜΟΤΗΤΑΣ EPS EPS THERMAL CONDUCTIVITY COEFFICIENT
λ=0.033 W/mK

## GET THE TIP

Το κάθε τζάμι FUSED είναι μοναδικό γιατί είναι χειροποίητο με ειδική καταργασία. Η απεικόνιση των σχεδίων στον κατάλογο μπορεί να διαφέρει μερικώς από το τελικό αποτέλεσμα στην εφαρμογή.

Each FUSED glass is unique due to its handmade special procedure so the designs that appear in the catalogue may be different from the final application.

# E2000 Series



E507



E508 Καίτι/Transom



E508 Ασφάλεια 1/Safety 1



E586



E587 Καίτι/Transom Inox

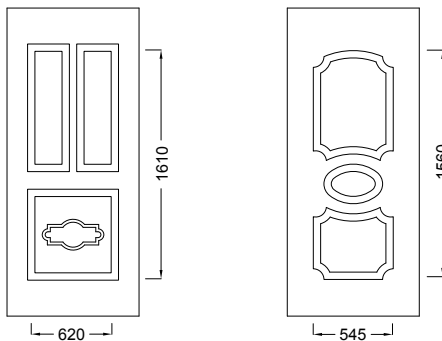



# E2000 Series



E529 Deco 1



E528

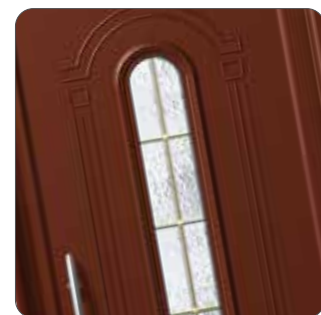

E529 Kaıti/Transom



E532



E533 Καίτι/Transom



E533 Ασφάλεια 4/Safety 4

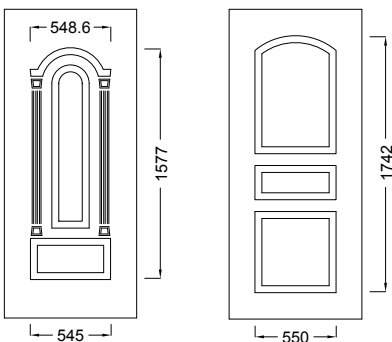

# E2000 Series



E537 Ασφάλεια 1/Safety 1



E536



E537 Fused 1

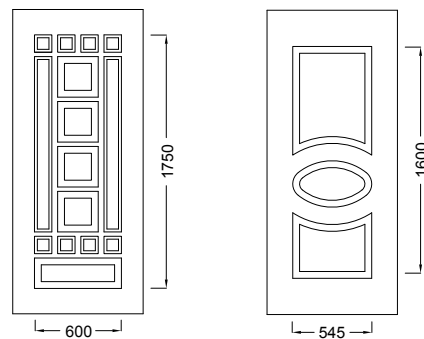



E535 Ασφάλεια 1/Safety 1



E534



E535 Καίτι/Transom

# E2000 Series



E810

E530



E531 Καίτι/Transom Inox



E531 Ασφάλεια 1/Safety 1

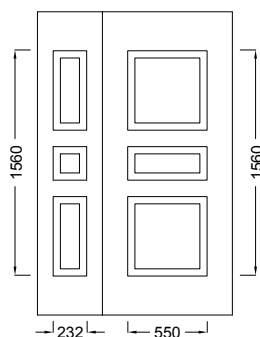





E545



E546 Καίτι/Transom

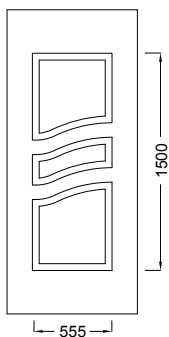

E546 Fused 2

# E2000 Series

Κλασικό Design σε 5 παραλλαγές  
5 Classic Designs



E903



E510



E504



E512



E513



E554



E540



E903



E517



E905 Ασφάλεια 2/Safety 2

E514 Ασφάλεια 3/Safety 3



E506 Ασφάλεια 1/Safety 1

E515 Ασφάλεια 1/Safety 1

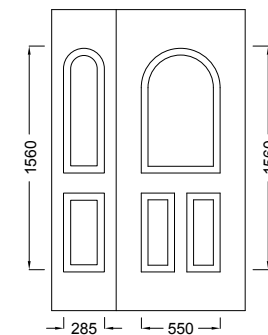
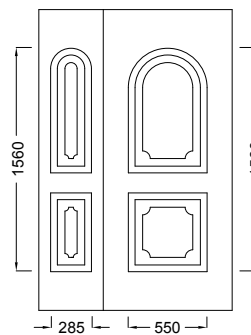
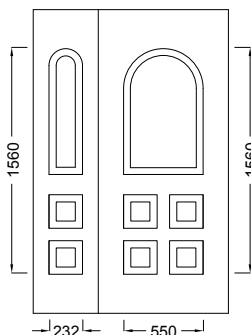
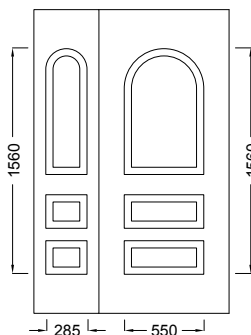
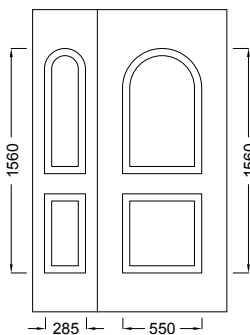

# E2000 Series

Κλασικό Design σε 5 παραλλαγές  
5 Classic Designs



E541 Ασφάλεια 1/Safety 1



E541 Ασφάλεια 2/Safety 2



E516 Ασφάλεια 2/Safety 2



Καϊτί/Transom



E516 Ασφάλεια 1/Safety 1



E905 Καίτι Ρόμβος/Transom Rhombus

E518 Καίτι Ρόμβος/Transom Rhombus



# E2000 Series



E506 Καράβολο/Karavolo

E551 Καράβολο/Karavolo



E504

E550

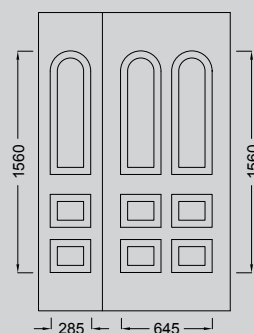

Καίτι/Transom



Deco 1



E551 Ασφάλεια 1/Safety 1



E856

E556

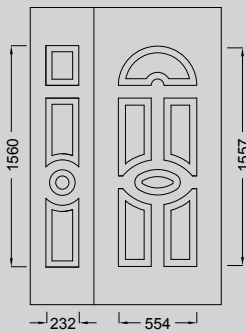

E858

E558 Καίτι/Transom



E557 Καίτι/Transom Inox



E557 Ασφάλεια 4/Safety 4

# E2000 Series



E565 Ασφάλεια 1/Safety 1



E564

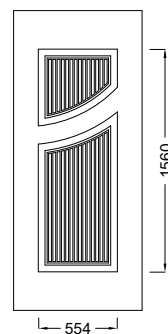



E569 Ασφάλεια 5/Safety 5



E572

E566

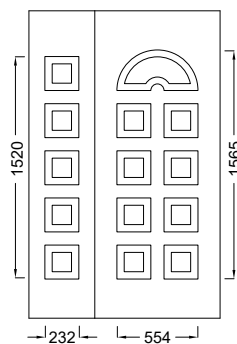

# E2000 Series



E562

E875



E563

E878



E562

E884



E563

E886



E563

E561



**ΕΙΔΙΚΟ ΣΧΕΔΙΟ 45cm ΠΛΑΤΟΣ**  
**SPECIAL DESIGN 45cm WIDTH**



E590

E580



E592 Καίτι/Transom

E583 Καίτι/Transom

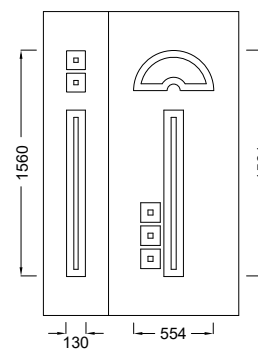
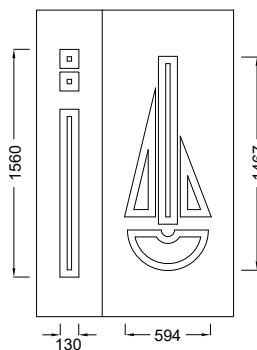
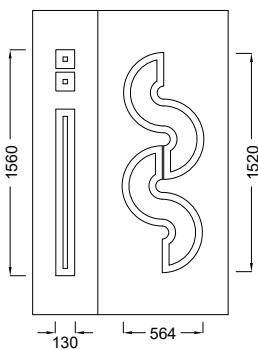

Όλα τα καίτια διατίθενται σε Λευκό, Χρυσό και Inox. All decorative transoms are available in White, Gold and Inox.

**E2000** Series

# E2000 Series



E908 Deco 2



E553 Deco 2

Ασφάλεια 1/Safety 1



E552

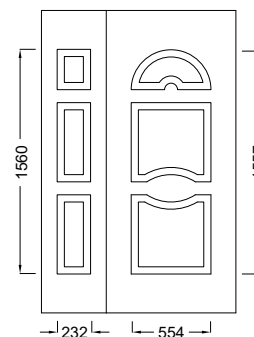
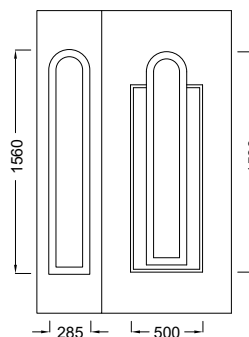



E988 Fused 4

E702 Fused 4



E700



E701 Fused 4



E702 Καίτι/Transom

# E2000 Series



E711 Καϊτί/Transom Inox



E711 Ασφάλεια 2/Safety 2



E710



Καϊτί/Transom

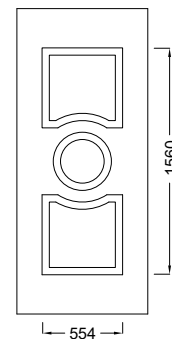



E727 Fused 9



E727 Ασφάλεια 6/Safety 6

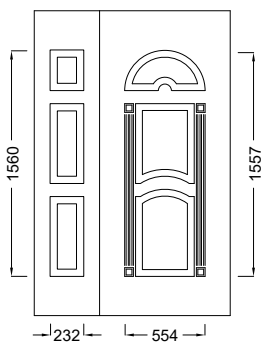

E725

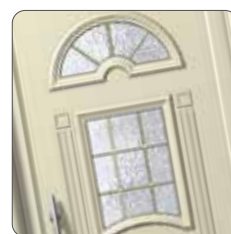

Καίτι/Transom

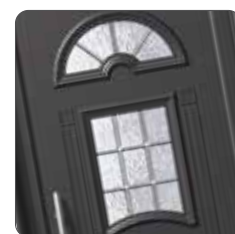

Καίτι/Transom Inox

Όλα τα καίτια διατίθενται σε Λευκό, Χρυσό και Inox. All decorative transoms are available in White, Gold and Inox.



# E2000 Series



E731 Ασφάλεια 1/Safety 1



E720



E728



E729 Ασφάλεια 1/Safety 1



E730 Ασφάλεια 1/Safety 1

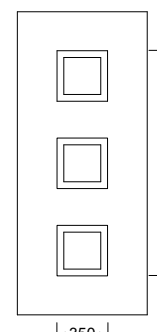
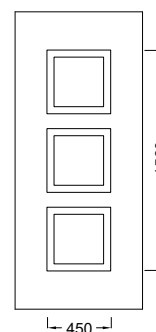



E860



E864 Ασφάλεια 1/Safety 1

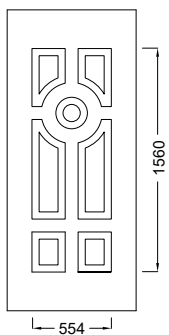

E864 Κάιτι/Transom Inox

# E2000 Series



E761 Ασφάλεια 5/Safety 5



E761 Καίτι/Transom



E760

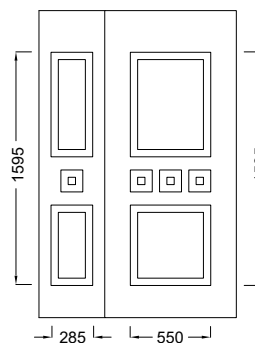



E740



E741 Ασφάλεια 4/Safety 4



E741 Ασφάλεια 1/Safety 1



Καίτι/Transom



Ασφάλεια 5/Safety 5

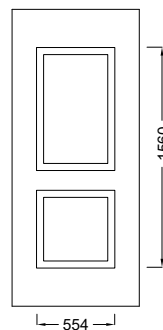

Όλα τα καίτια διατίθενται σε Λευκό, Χρυσό και Inox. All decorative transoms are available in White, Gold and Inox.

# E2000 Series



E783



E780



E785

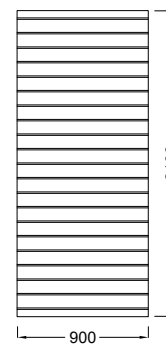
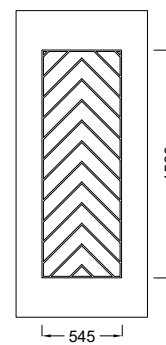
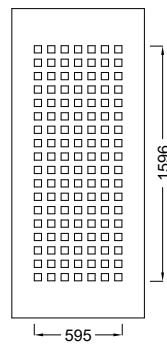
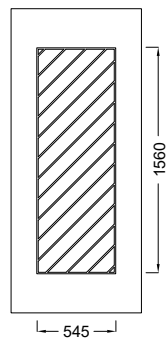
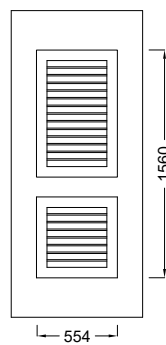
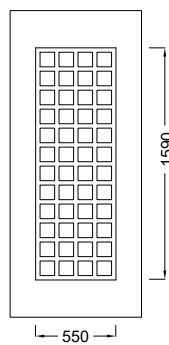
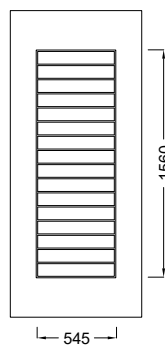





E781



E789



E784



E782



E714

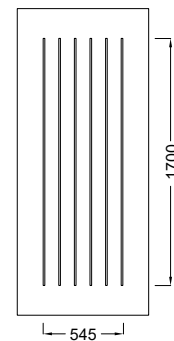

Όλα τα καίτια διατίθενται σε Λευκό, Χρυσό και Inox. All decorative transoms are available in White, Gold and Inox.

# E2000 Series



E792 Ασφάλεια 4/Safety 4



Καίτι/Transom Inox



E790



E791 Καίτι/Transom

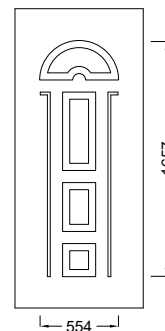



E750



E751 Deco 1

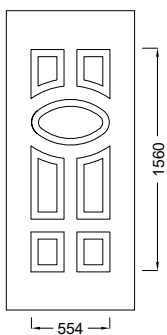

# E2000 Series



E770

E771 Καίτι/Transom Inox



E771 Ασφάλεια 1/Safety 1

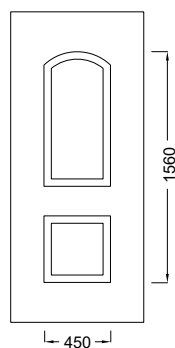



E800

E803 E801 Fused 4



E807 Fused 4

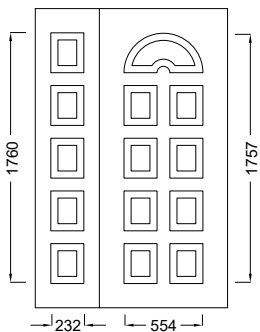

Καίτια/Transom



Ασφάλεια 4/Safety 4



Deco 1



# E2000 Series



E812



E811 Καίτι/Transom Inox

E814 Καίτι/Transom Inox

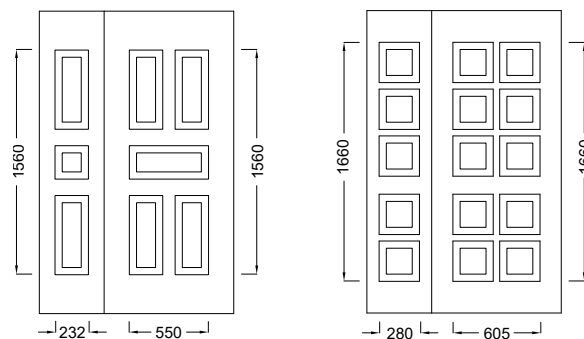



E520



E820 E523 Ασφάλεια 1/Safety 1

E826 Ασφάλεια 1/Safety 1



Καίτι/Transom

Όλα τα καίτια διατίθενται σε Λευκό, Χρυσό και Inox. All decorative transoms are available in White, Gold and Inox.

# E2000 Series



E848 Ασφάλεια 1/Safety 1



E848 Καίτι/Transom Inox



E847

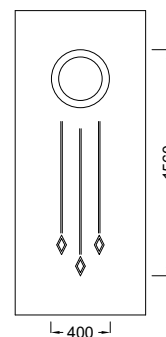



E846 Ασφάλεια 1/Safety 1



E846 Καίτι/Transom

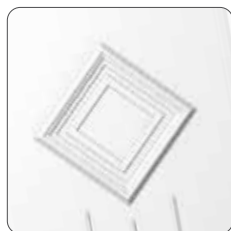

E845

# E2000 Series



E851 Ασφάλεια 4/Safety 4

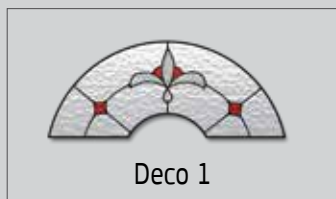

Deco 1



E855L Καίτι/Transom

E851 Καίτι/Transom

E855R Καίτι/Transom



E850

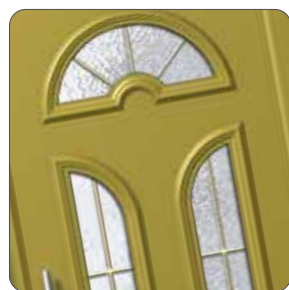

E853 Καίτι/Transom

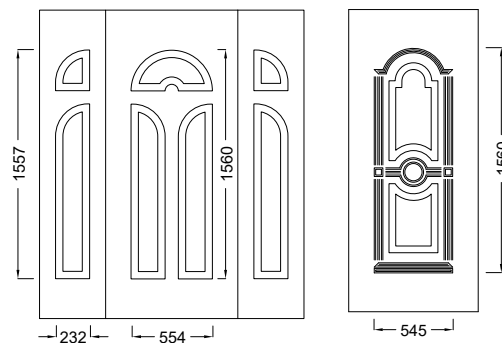





E870



E871 Deco 1



E871 Ασφάλεια 3/Safety 3



Καίτι/Transom



Ασφάλεια 1/Safety 1



Ασφάλεια 2/Safety 2

# E2000 Series



E865



E873 E866

E874 Καίτι/Transom



Deco 1

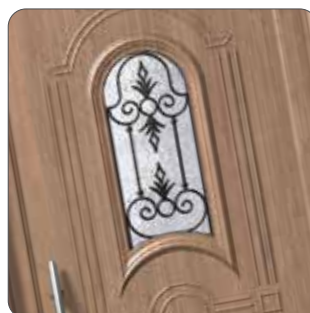

Ασφάλεια 2/Safety 2



Ασφάλεια 3/Safety 3



E881 Deco 2



E880



Καίτι/Transom



E881 Ασφάλεια 1/Safety 1

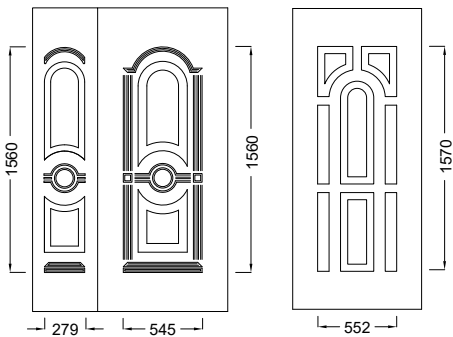

# E2000 Series



E895



Kaıtı/Transom

E893 Kaıtı/Transom Inox

E896 Kaıtı/Transom Inox



E897



E898 Καίτι/Transom

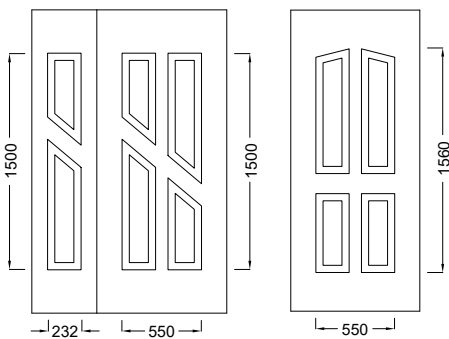



# E2000 Series



E905 Ασφάλεια 1/Safety 1

E900 Ασφάλεια 1/Safety 1



E905 Καράβολο/Karavolo

E900 Καράβολο/Karavolo





E902



Καίτι/Transom

E900 Deco 2



E900 Deco 1

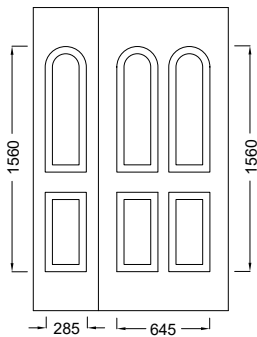

# E2000 Series



E905 Ασφάλεια 1/Safety 1

E911 Ασφάλεια 1/Safety 1



E911 Ασφάλεια 2/Safety 2



E910

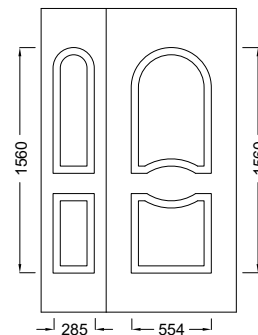



E934 Ασφάλεια 1/Safety 1

E928 Ασφάλεια 1/Safety 1



E928 Ασφάλεια 2/Safety 2



E926



Καίτι/Transom



Καίτι/Transom Inox

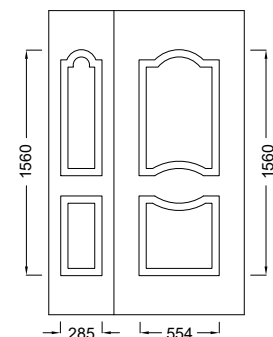

# E2000 Series



E943 Ασφάλεια 1/Safety 1



E943 Ασφάλεια 3/Safety 3



E941



Καίτι/Transom

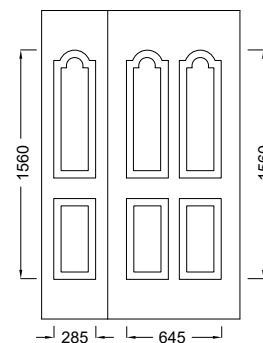



E922



E923

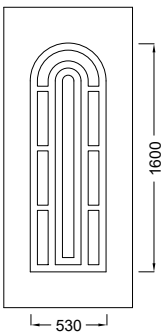

# E2000 Series



E958



E960 Vitro 1





E951



Καίτι/Transom



E957



E952 Καίτι/Transom Inox

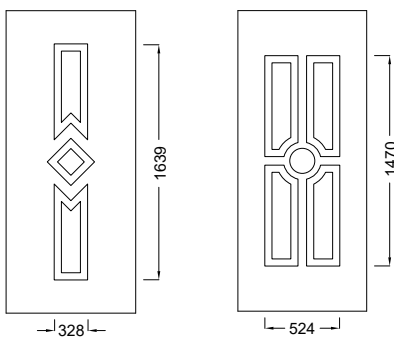

# E2000 Series



E983 Deco 1



E988 Fused 1

E983 Fused 1

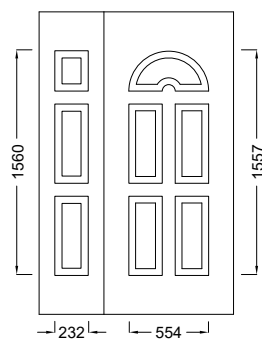

E982



E983 Καίτι/Transom



E981 Καίτι Inox  
Transom Inox



E983 Ασφάλεια 1/Safety 1



E983 Καράβολο/Karavolo

# E2000 Series



E210

E200



E986

E990 E988 Καίτι/Transom



E994 Καίτι/Transom

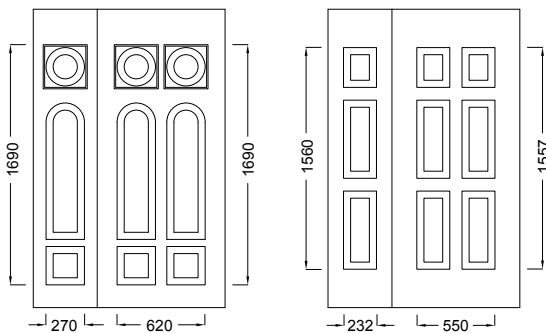

Όλα τα καίτια διατίθενται σε Λευκό, Χρυσό και Inox. All decorative transoms are available in White, Gold and Inox.

# P6000 Series



P6110



P6150





# Ασφάλεια | Security

- Ασφάλεια
- Στιβαρή κατασκευή βαρέως τύπου με ενισχυμένα φύλλα αλουμινίου 1.2 mm
- Εξωτερικό πάτημα με ενσωματωμένο ταμπλά αλουμινίου
- Τζάμια διπλής υάλωσης με triplex τζάμι ασφαλείας
- Αυξημένη θερμομόνωση & ηχομόνωση
- Αναλλοίωτες και πιστοποιημένες βαφές και αποχρώσεις ξύλου
  
- Safety and protection
- Heavy duty pressed aluminium panel 1.2 mm thickness
- Double glazing with triplex safety glass
- Exceptional heat and sound insulation coefficient
- Certified powder coatings and wood imitation shades

ΠΑΧΟΣ ΦΥΛΛΟΥ ΑΛΟΥΜΙΝΙΟΥ ALUMINIUM SHEET THICKNESS
1.2 mm
ΣΥΝΟΛΙΚΟ ΠΑΧΟΣ ΠΑΝΕΛ TOTAL PANEL THICKNESS
23-25 mm
ΑΠΟΚΟΛΗΣΗ ΚΟΡΝΙΖΑΣ ΑΠΟ ΕΠΙΦΑΝΕΙΑ ΤΟΥ ΠΑΝΕΛ FRAME DETACHMENT FROM PANEL SURFACE
50.02 Pa/mm <sup>2</sup>
ΑΠΟΚΟΛΗΣΗ ΦΥΛΛΟΥ ΑΛΟΥΜΙΝΙΟΥ ΑΠΟ ΜΟΝΩΤΙΚΟ SHEET DETACHMENT FROM INSULATION MATERIAL
0.488 N/mm <sup>2</sup>
ΘΕΡΜΟΠΕΡΑΤΟΤΗΤΑ ΠΑΝΕΛ PANEL THERMAL CONDUCTIV- ITY
U <sub>p</sub> =1.08 W/m <sup>2</sup> K (max)
ΣΥΝΤΕΛΕΣΤΗΣ ΘΕΡΜΙΚΗΣ ΑΝΤΙΣΤΑΣΗΣ ΠΑΝΕΛ PANEL THERMAL RESISTANCE COEF- FICIENT
R <sub>p</sub> =0.93 m <sup>2</sup> K/W (max)
ΣΥΝΤΕΛΕΣΤΗΣ ΘΕΡΜΙΚΗΣ ΑΓΩΓΙΜΟΤΗΤΑΣ EPS EPS THERMAL CONDUCTIVITY COEF- FICIENT
λ=0.033 W/mK



# P6000 Series



P6600

P6100



P6601 Καίτι/Transom

P6101 Καίτι/Transom



P6101 Ασφάλεια 4/Safety 4

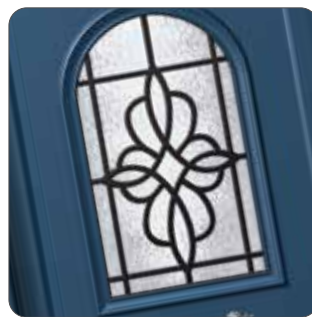

Ασφάλεια 1/Safety 1



P6110



P6111 Καίτι/Transom



P6111 Ασφάλεια/Safety 5



# P6000 Series



P6120



P6121 Καίτι/Transom



P6121 Ασφάλεια 2/Safety 2



P6196 Καίτι/Transom



P6196 Ασφάλεια 1/Safety 1





# P6000 Series



P6630

P6130



P6632 Kaıtı/Transom

P6133 Kaıtı/Transom





P6142 Καίτι/Transom

# P6000 Series



P6150



P6151 Καίτι/Transom Inox



P6153 Ασφάλεια 1/Safety 1



P6700

P6200



P6701 Καίτι/Transom

P6201 Καίτι/Transom



P6201 Deco 1

# P6000 Series



P6740

P6230



P6160



P6741 Ασφάλεια 1/Safety 1

P6231 Ασφάλεια 1/Safety 1



P6161 Ασφάλεια 5/Safety 5



P6161 Ασφάλεια 4/Safety 4



Καίτι/Transom



Ασφάλεια 1/Safety 1



Ασφάλεια 3/Safety 3



# P6000 Series



P6170



P6171 Καίτι/Transom



P6171 Ασφάλεια 4/Safety 4





P6711

P6221 Καίτι/Transom



P6221 Ασφάλεια 1/Safety 1

# P6000 Series



P6710

P6210



P6212 Καράβολο/Karavolo



P6212 Ασφάλεια 1/Safety 1



P6212 Καίτι/Transom



P6740

P6240



P6741 Καίτι/Transom Inox

P6242 Καίτι/Transom Inox



P6242 Ασφάλεια 3/Safety 3



Ασφάλεια 1/Safety 1

# P6000 Series



P6750

P6250



P6253 Καίτι/Transom



P6255 Καίτι/Transom



P6253 Ασφάλεια 1/Safety 1



# Ταμπλαδάκια / Special size panels

Ειδικά πάνελ για κουζινόπορτες και παραδοσιακά παράθυρα  
Special size panels for kitchen doors and windows

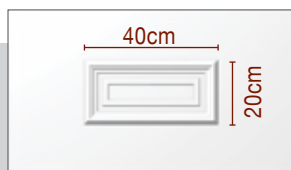

E544 (90x52.5 cm)



E542 (90x210 cm)

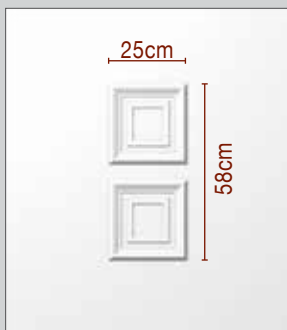

E525 (90x105 cm)

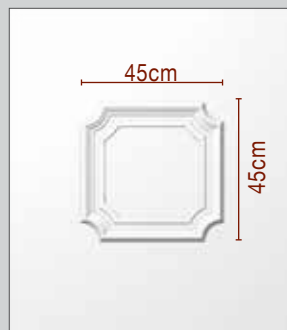

E538 (90x105 cm)

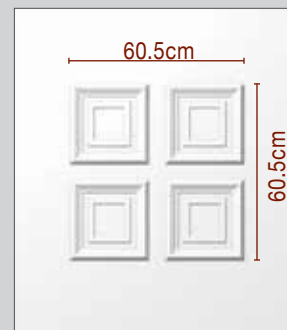

E543 (90x105 cm)



E595 (90x105 cm)

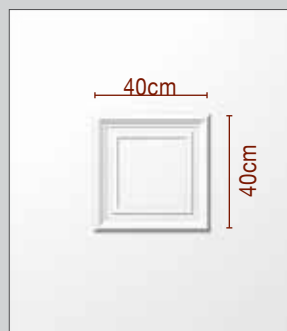

E596 (90x105 cm)



E597 (90x105 cm)



E594 (90x210 cm)



E794 (90x210 cm)



E598 (90x210 cm)

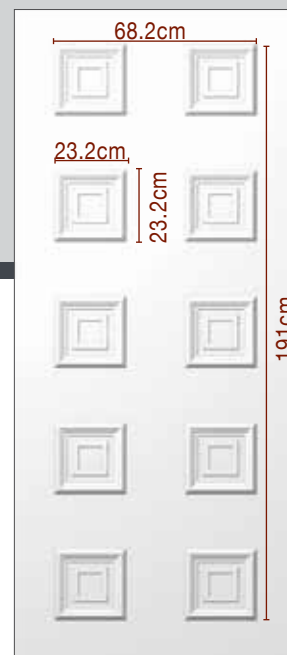

E599 (90x210 cm)



# FP-20 Aluplast / PVC

Επίπεδα πάνελ αλουμινίου  
Aluminium flat panels

- Ενισχυμένη αντοχή σε χτυπήματα
- Σκληρή - Άκαμπτη επιφάνεια
- Αυξημένη Ηχομόνωση
- Ελαφρύ
- Κατάλληλο για ποικίλες εφαρμογές
- Highly resistant material
- Hard, rigid surface
- Increased sound insulation
- Light weight
- Appropriate for various applications

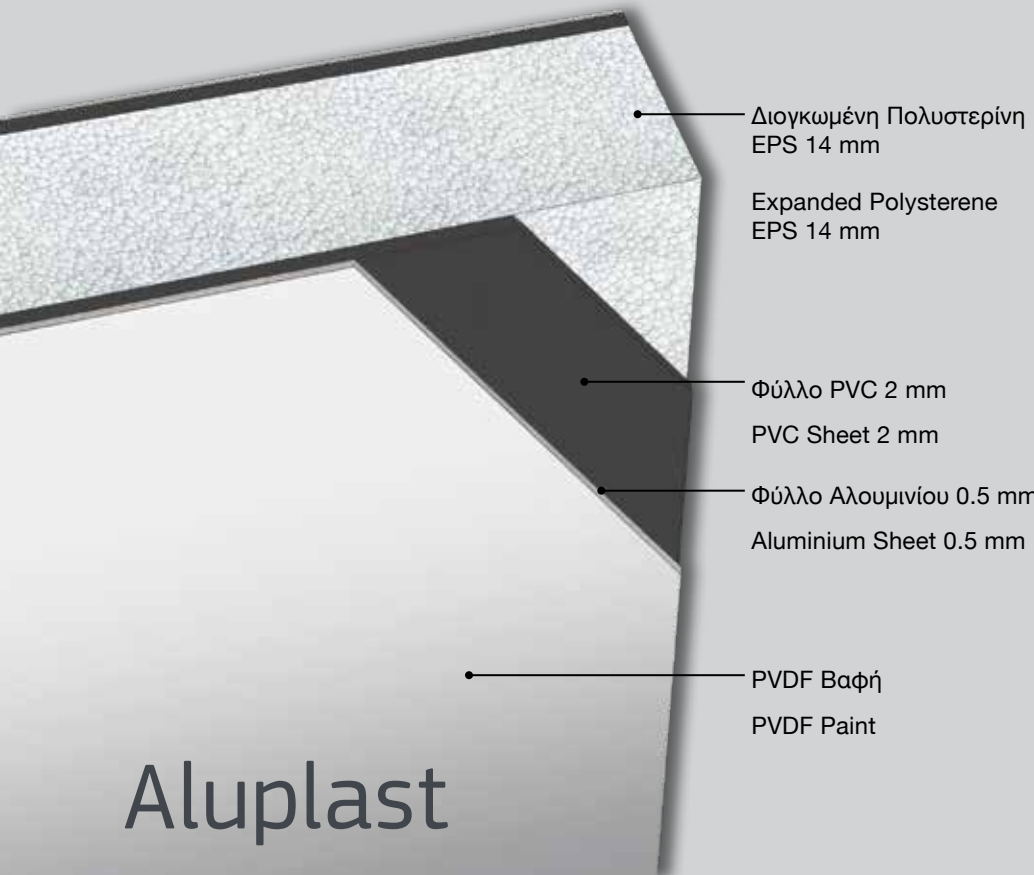

Διογκωμένη Πολυστερίνη  
EPS 14 mm

Expanded Polysterene  
EPS 14 mm

Φύλλο PVC 2 mm  
PVC Sheet 2 mm

Φύλλο Αλουμινίου 0.5 mm  
Aluminium Sheet 0.5 mm

PVDF Βαφή  
PVDF Paint

Aluplast

ΣΥΝΟΛΙΚΟ ΠΑΧΟΣ ΠΑΝΕΛ TOTAL PANEL THICKNESS	<b>20 mm</b>
ΑΠΟΚΟΛΛΗΣΗ ΦΥΛΛΟΥ ALUMINIUM SHEET DETACHMENT	<b>0.488 N/mm<sup>2</sup></b>
ΘΕΡΜΟΠΕΡΑΤΟΤΗΤΑ ΠΑΝΕΛ PANEL THERMAL CONDUCTIVITY	<b>U<sub>p</sub>=1.92 W/m<sup>2</sup>K</b>
ΣΥΝΤΕΛΕΣΤΗΣ ΘΕΡΜΙΚΗΣ ΑΝΤΙΣΤΑΣΗΣ ΠΑΝΕΛ PANEL THERMAL RESISTANCE COEFFICIENT	<b>R<sub>p</sub>=0.52 m<sup>2</sup>K/W</b>
ΣΥΝΤΕΛΕΣΤΗΣ ΘΕΡΜΙΚΗΣ ΑΓΩΓΙΜΟΤΗΤΑΣ EPS EPS THERMAL CONDUCTIVITY COEFFICIENT	<b>λ=0.033 W/mK</b>
ΚΡΑΜΑ / ALLOY	<b>AL 3105/H44</b>
ΒΑΦΗ ΕΠΙΦΑΝΕΙΑΣ / SURFACE COATING	<b>PVDF, PRIMER</b>
ΠΑΧΟΣ ΑΛΟΥΜΙΝΙΟΥ ALUMINIUM THICKNESS	<b>0.5 mm</b>
ΠΑΧΟΣ PVC / PVC THICKNESS	<b>2 mm</b>
ΠΑΧΟΣ ΠΟΛΥΣΤΕΡΙΝΗΣ POLYSTYRENE THICKNESS	<b>14 mm</b>

	Code	Dimensions
Aluplast	FP090-210/5	900x2100
	FP120-250/5	1200x2500

# Χειρολαβές / Handles

Επιλογές απο ποικιλία σχεδίων και υλικών, που συνδυάζονται άψογα με όλες τις πόρτες  
 Wide selection of handle designs and materials, to match any type of door

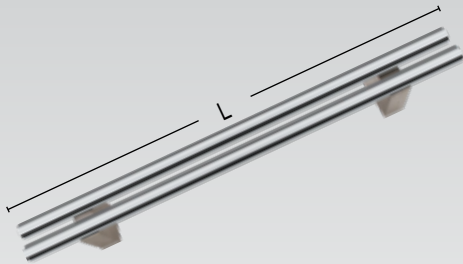

L40cm	0871X2-040
L50cm	0871X2-050
L60cm	0871X2-060
L80cm	0871X2-080
L100cm	0871X2-100
L120cm	0871X2-120
L150cm	0871X2-150
L160cm	0871X2-160
L180cm	0871X2-180
L200cm	0871X2-200

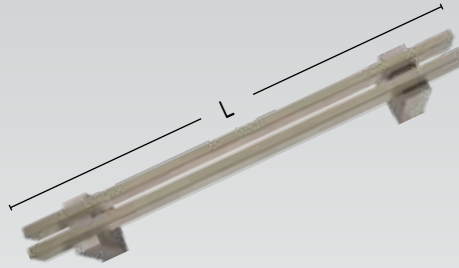

L40cm	0873X1-040
L50cm	0873X1-050
L60cm	0873X1-060
L80cm	0873X1-080
L100cm	0873X1-100
L120cm	0873X1-120
L150cm	0873X1-150
L160cm	0873X1-160
L180cm	0873X1-180
L200cm	0873X1-200

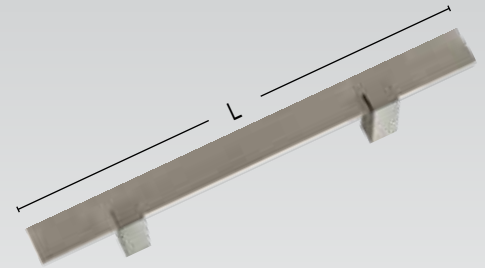

L40cm	0879X3-040
L50cm	0879X3-050
L60cm	0879X3-060
L80cm	0879X3-080
L100cm	0879X3-100
L120cm	0879X3-120
L150cm	0879X3-150
L160cm	0879X3-160
L180cm	0879X3-180
L200cm	0879X3-200

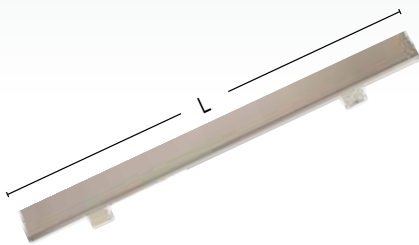

L40cm	0669X3-040
L50cm	0669X3-050
L60cm	0669X3-060
L80cm	0669X3-080
L100cm	0669X3-100
L120cm	0669X3-120
L150cm	0669X3-150
L160cm	0669X3-160
L180cm	0669X3-180
L200cm	0669X3-200

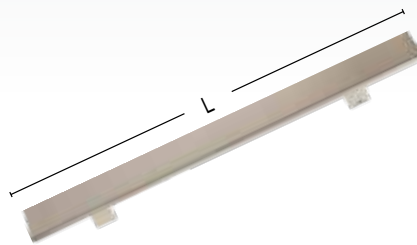

L40cm	0670X3-040
L50cm	0670X3-050
L60cm	0670X3-060
L80cm	0670X3-080
L100cm	0670X3-100
L120cm	0670X3-120

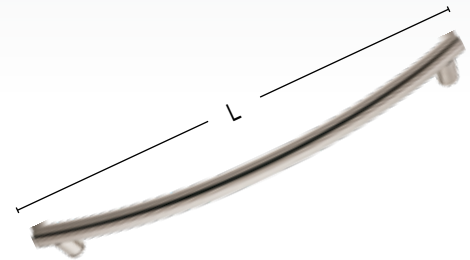

L45.5cm	0461X3-040
L65.7cm	0461X3-060
L85.8cm	0461X3-080
L105.9cm	0461X3-100

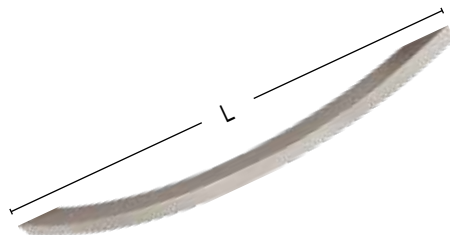

L30cm	0883X1-025
L55.5cm	0883X1-050

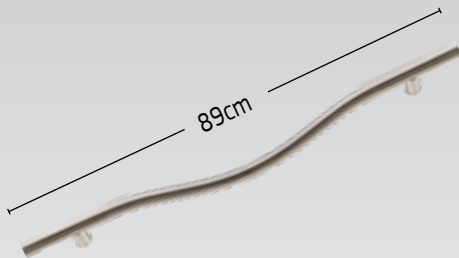

0617X3-089

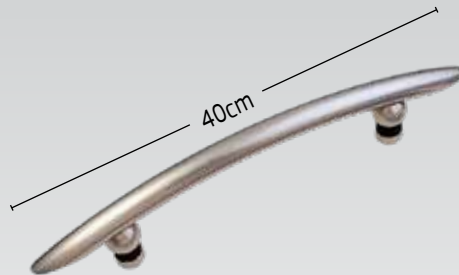

102

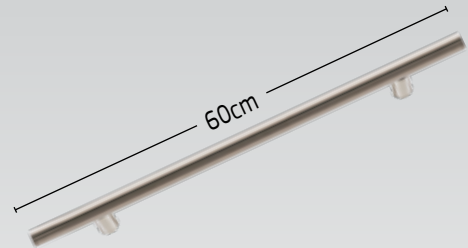

165-500

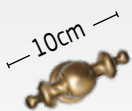

521

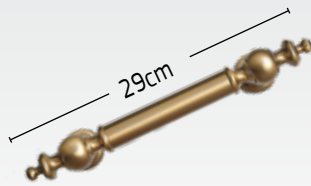

520

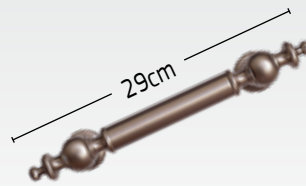

520S



165-400



Ø50mm 0449P3-005  
Ø60mm 0449P3-006  
Ø70mm 0449P3-007  
Ø80mm 0449P3-008



Ø60mm 0697P4-006  
Ø80mm 0697P4-008



60x60mm 0785P4-006  
80x80mm 0785P4-008

# SECURITY DOOR LOCK

## Mortise and Falling latch INOX / NICKEL

Κλειδαριές ασφαλείας, μαχαιρωτή και γλωσσού, σε Inox & Nickel, κατάλληλες για όλες τις σειρές αλουμινίου

### Πλεονεκτήματα

- 5ετή εγγύηση καλής λειτουργίας
- Μοναδική τιμή
- Κύλινδρος ασφαλείας με 5 πλακέ κλειδιά
- Πλάκα και αντίκρισμα και από ανοξείδωτο ατσάλι για προστασία από την βροχή και την αλμύρα
- Εξαιρετικά εύκολο στη χρήση
- Ρυθμιζόμενη γλώσσα για άνετη εφαρμογή με ακρίβεια δεξιάς ή αριστερής φοράς από την μπροστινή πλευρά για μέγιστη ευελιξία και ταχύτητα
- Έρχεται σε ειδική συσκευασία που χρησιμοποιείται σαν θήκη φύλαξης και μεταφοράς

Security door locks, mortise & falling latch, in Inox & Nickel, suitable for all aluminium series

### Advantages

- 5 year warranty
- Best price value
- Lock cylinder with 5 keys plywood
- Plate & striking plate for locks from stainless steel for protection from the rain and the saltiness
- Extremely easy to use
- Adjustable latch for a comfortable fit with accuracy, right or left direction of the front panel for maximum flexibility and swiftness
- Special packaging used as a storage box





## 1<sup>ο</sup> Σετ / 1<sup>st</sup> Set

A/A	Κωδικός σετ Set Code	Περιγραφή   Description
1	KT710-728/01	Κλειδ. 35mm Γλωσσού Inox & Κύλινδ. 75mm ασφαλείας Lock 35mm Mortise Inox & Security Cylinder 75mm
2	KT710-728/02	Κλειδ. 35mm Γλωσσού Nickel & Κύλινδ. 75mm ασφαλείας Lock No 35mm Mortise Nickel & Security Cylinder 75mm
3	KT710-725/01	Κλειδ. 35mm Γλωσσού Inox & Κύλινδ. 85mm ασφαλείας Lock 35m Mortise Inox & Security Cylinder 85mm
4	KT710-725/02	Κλειδ. 35mm Γλωσσού Nickel & Κύλινδ. 85mm ασφαλείας Lock 35mm Mortise Nickel & Security Cylinder 85mm

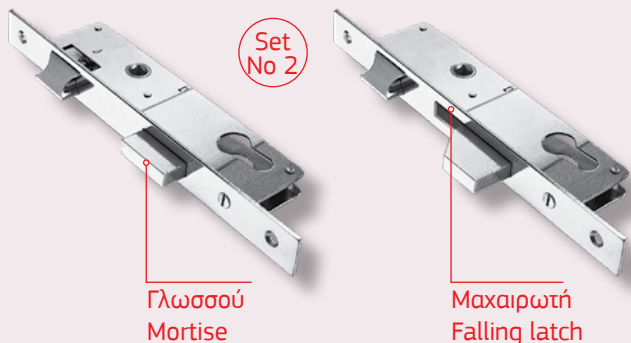

## 2<sup>ο</sup> Σετ / 2<sup>nd</sup> Set

A/A	Κωδικός σετ Set Code	Περιγραφή   Description
1	KT709-724	Κλειδ. 20mm Γλωσσού Inox & Κύλινδ. 60mm απλός Lock 20mm Mortise Inox & Cylinder 60mm
2	KT712-728	Κλειδ. 30mm Γλωσσού Inox & Κύλινδ. 75mm ασφαλείας Lock 30mm Mortise Inox & Security Cylinder 75mm
3	KT712-725	Κλειδ. 30mm Γλωσσού Inox & Κύλινδ. 85mm ασφαλείας Lock 30mm Mortise Inox & Security Cylinder 85mm
4	KT703-728	Κλειδ. 35mm Μαχαιρωτή Inox & Κύλινδ. 75mm ασφαλείας Lock 35mm Falling latch Inox & Security Cylinder 75mm
5	KT703-725	Κλειδ. 35mm Μαχαιρωτή Inox & Κύλινδ. 85mm ασφαλείας Lock 35mm Falling latch Inox & Security Cylinder 85mm



# HDS **ULTRA** **PLUS**

Πρωτοποριακή σύνθεση υλικών για ακόμα μεγαλύτερη ηχομόνωση στα Πάνελ Αλουμινίου.

Innovative composition of materials for even more sound insulation in Aluminium Panels.

## **Πλεονεκτήματα**

Αυξημένη ηχομόνωση.

Απόλυτη ποιότητα.

Ασυναγώνιστη λειτουργικότητα.

## **Benefits**

Advanced sound insulation.

Top quality.

Unrivalled functionality.





## Τεχνικά Χαρακτηριστικά

Συνολικό πάχος πάνελ HDS Ultra Plus: 23-23.5 mm  
(ανάλογα με την κατηγορία του πάνελ)

Διαστάσεις πάνελ: 900x2100, 450x2100, 900x1050,  
900x525, 1000x2250 mm

## Technical Characteristics

Total panel thickness HDS Ultra Plus: 23-23.5  
mm (depending on the panel category)

Panel dimensions: 900x2100, 450x2100,  
900x1050, 900x525, 1000x2250 mm

GET THE  
TIP

Τα σχέδια πάνελ με κωδικό I423, I428, I451  
εξαιρούνται από την σύνθεση HDS Ultra Plus  
λόγω της ιδιομορφίας τους και είναι διαθέσιμα  
μόνο σε Styrofoam.

Panel designs with code i423, i428, i451 are  
excluded from the composition HDS Ultra  
Plus because of their special nature and they  
are available in Styrofoam.





**ALUMINCO**<sup>®</sup>  
ALUMINIUM BUILDING SYSTEMS

INOFITA VIOTIA 32011 GREECE

TEL: +30 22620 47000

FAX: +30 22620 47092

[info@aluminco.com](mailto:info@aluminco.com)

[www.aluminco.com](http://www.aluminco.com)

Έκδοση / Version 2021